

Vol. 6

TOOL  
TRACKER  
INSIDE  
pg. **4**

# 2019

## HDD TOOL CATALOG

**radius**<sup>®</sup>  
TOOLS FOR HDD PROFESSIONALS

Order Your Way  
800-892-9114  
[RadiusHDD.com](http://RadiusHDD.com)

# CALL Or CLICK

Order Your Way.

**You're busy and we know it.**

So we've given you more ways to order, whether you are in the middle of town, or the middle of nowhere. Just call our toll-free number. Or order online.

**You can even find Radius® tools at participating dealers worldwide.**



# Find It Fast.

Drive Chucks &  
Sub Savers **8**

Starter Rods &  
Quick Connects **12**

Adaptors & Subs **14**

Housings **18**

Rock Tools **24**

Bits & Blades **34**

Reamers **40**

Swivels **46**

Parts &  
Accessories **48**

Repairs **55**



# TOOL TRACKER

No more guessing. Reduce confusion and minimize downtime by having important rig and tooling specs in one place – here!

<b>Rig Model</b>		<b>Fleet #</b>	
<b>Serial #</b>			
<b>Pump Model</b>		<b>Serial #</b>	

<b>Drive Chuck Part #</b>	<b>Overall Length</b>	<b>Flange OD</b>	<b>Pipe Thread</b>
<b>If 2 Piece Chuck</b>	<b>Sub Saver Part #</b>	<b>Flange OD</b>	<b>Pipe Thread</b>

<b>Drill Pipe Part #</b>	<b>Length</b>	<b>MFG</b>	<b>Thread</b>
<b>Vice Jaw Part #HYD</b>	<b>Vice Jaw Part #STAT</b>	<b>Pipe Size</b>	
<b>Rod Wiper Part #</b>	<b>Single or Dual Split</b>	<b>Tube Size</b>	
<b>Thread Grease Part #</b>	<b>Brand</b>	<b>1,2, or 5 Gallon Pail</b>	

<b>Quick Connect</b>	<b>Lead Rod Part #</b>	<b>Thread</b>	<b>Type or MFG</b>
<b>QC Collar</b>	<b>Flat To Flat Dim</b>	<b>Hex or Octagon</b>	<b>Pipe Thread</b>
<b>Sonde Housing #</b>	<b>Body Diameter</b>	<b>Thread</b>	<b>Electronics</b>
<b>Tailpiece Part #</b>	<b>Pipe Thread (Direct)</b>	<b>QC Thread (Type)</b>	

<b>Preference</b>	<b>Blonde</b>	<b>Brunette</b>	<b>Redhead</b>
-------------------	---------------	-----------------	----------------

# **RADIUS HDD** is committed to HDD tools.

It's all we do. While a number of our customers are business heads, owners and managers, we consistently work directly with the "men in the mud". That is where our business started and will always be focused. By listening, watching and working with HDD operators and crews, we hear first hand what works and what doesn't. That input - your input - directly drives our business.

More than a decade into business, Radius offers a complete line of the highest quality tools to HDD professionals worldwide through the most comprehensive catalog and website in the industry. We will continue to work in the mud with contractors to listen and build the toughest and most innovative tools to help you tackle the challenges you face everyday.

We are proud of every driller that puts their confidence in our tool and will continue to work hard everyday to build that trust.

Team Radius





# BUILD AND ORDER YOUR CUSTOM SUB ONLINE.

It's easy to use. And you can get it the next day. Because Radius has machines dedicated to same-day production.



*A better experience,  
website to jobsite.*

Radius offers today's HDD Pro more than 2,000 tools. But one of the most important tools you can take advantage of is RadiusHDD.com.

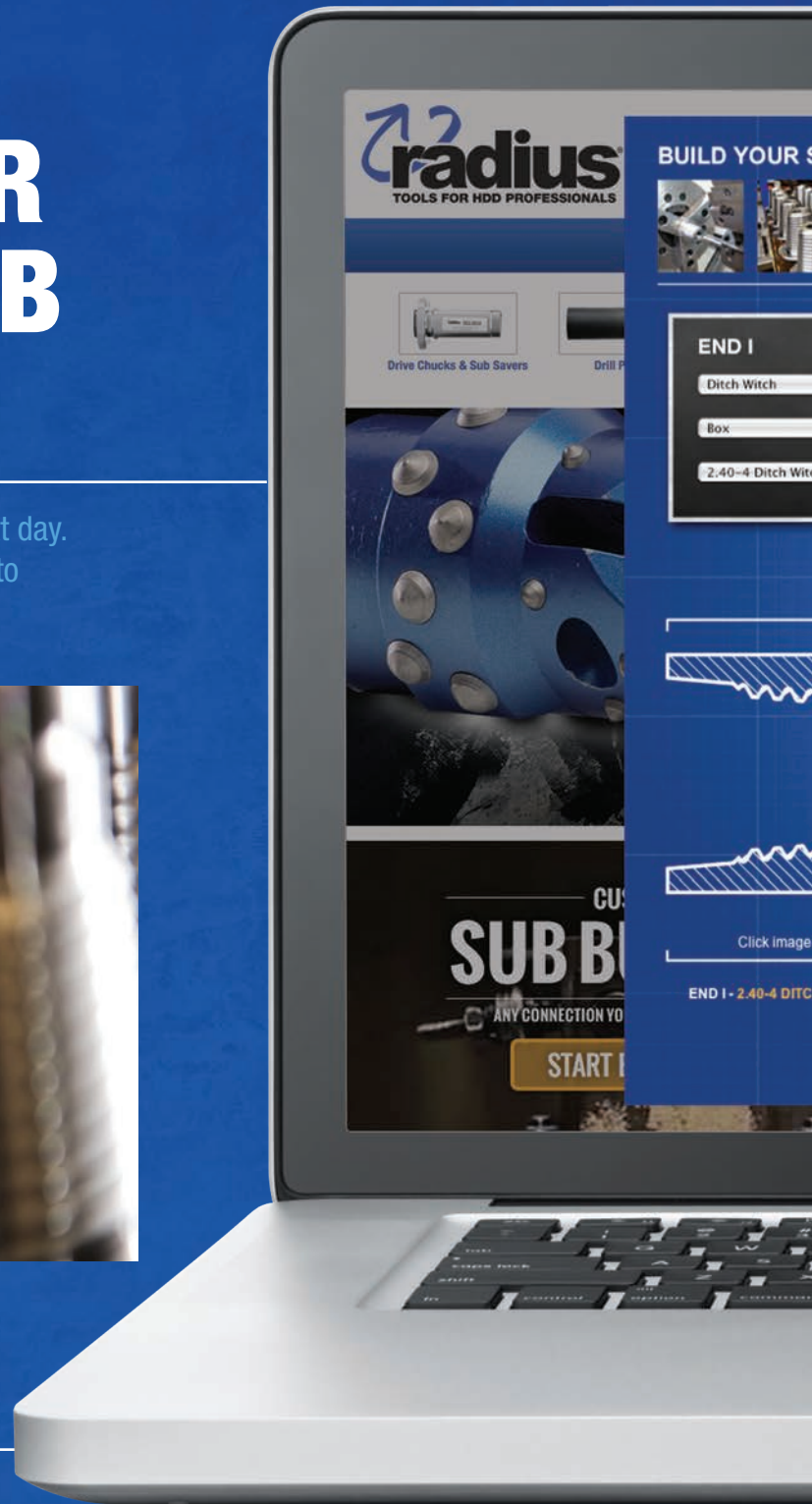

**ORDER YOUR WAY. GET IT TOMORROW**

We can build a custom sub to your specifications and ship it the same day when you order before 1 pm CST.

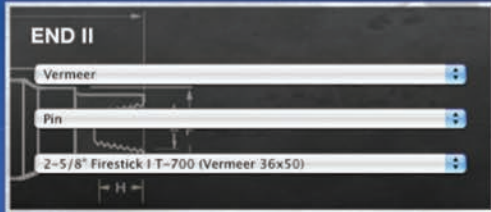
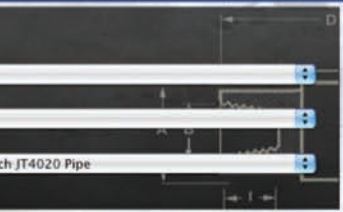
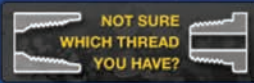

OVERALL LENGTH (IN.) **13**

OVERALL LENGTH - 13 (IN.)

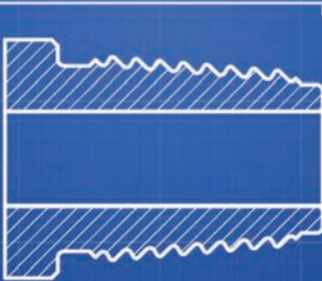

Click image for more detail.

Click image for more detail.

DITCH WITCH JT4020 PIPE

END II - 2-5/8" FIRESTICK I T-700 (VERMEER 36X50)

### DETAILS

End1 2.40-4 Ditch Witch JT4020 Pipe  
End2 2-5/8" Firestick I T-700 (Vermeer 3...  
Overall Length 13 Inches  
Shoulder to Shoulder 6.00 Inches  
Material Diam 3.25  
Hardness 32-36 Rockwell C

I have read, understand and agree to the [terms and conditions](#).

**Buy Now**

Ship next day: \$249.03

*\*Shipping charges will be calculated at checkout*

air | Catalog | Contact | Log In

855-471-2771



# PRECISION MACHINED FOR PRECISE PERFORMANCE.

Our drive chucks are built to the exact specifications of the original equipment manufacturer using heat treated alloy **for maximum durability.**

*“We use Radius tooling everyday. Have tried others, but nothing compares to the durability and value of Radius tooling. Their service is top notch and their website is extremely helpful. I’m a big fan and will be a life long customer.”*

-Johnny Nixon



**Ditch Witch® Compatible 1 Pc. Drive Chucks / Sub Savers**

Part #	Fits Model	Thread Type	Overall Length
953-0029	JT5	1.10 - 5 Pipe Box	6.5"
953-0030	JT520	1.21 - 6 Pipe Box	4.75"
953-0031	JT920L/921	1.41 - 6 Pipe Box	6.375"
953-0032	JT922	1.30 - 5 Coarse Thread Pipe Box	9.5"
953-0218	JT922	1.41 - 6 Pipe Box	9.5"
953-0033	JT1220 / JT1220M1	1.47 - 4 Pipe Box	9.875"
953-0034	JT1720 / JT1720M1	1.69 - 6 Pipe Box	6.375"
953-0035	JT2020M1	1.94 - 4 Pipe Box (Square flange)	10.875"
953-0036	JT2720	1.94 - 4 Pipe Box	9.875"
953-0037	JT2720M1	2.11 - 4 Pipe Box	19.25"
953-0038	JT3020M1	2.11 - 6 Pipe Box	27.25"
953-0039	JT4020	2.40 - 4 Pipe Box	9.5"
953-0217	JT4020AT	3.25 - 4 Pipe Box	27.625"
953-0040	JT4020M1	2.59 - 4 Pipe Box	20.5"
953-0041	JT7020 / JT8020 / JT100M1	3.27 - 4 Pipe Box	24.25"
953-0243	JT2720AT	2.77 - 4 Pipe Box	27.625"
953-0267	JT3020AT	2.77 - 4 - Pipe Box	27.625"
953-0268	AT100AT	3.44 - 4 Pipe Box	27.625"
953-0335	JT2720M1	2.11 - 4 Pipe Box / Large Flange	19.375"
953-0367	JT100	3.27 - 4 Pipe Box	25.375"
953-0373	JT4020M1	2.59 - 4 Pipe Box / Large Flange	25.25"

**Ditch Witch® Compatible Conversion Drive Chucks**

Part #	Fits Model	Thread Type	Overall Length
953-0407	JT922 Box Down	1.66" Firestick 1 Pipe (200) (1PC)	9.9"
953-0456	JT922 Box Down	1.66" Firestick 1 Pipe (200) (2PC)	9.9"
953-0256	JT922 Pin Down	1.66" Firestick 1 Pipe (200) (1PC)	10.9"
953-0457	JT922 Pin Down	1.66" Firestick 1 Pipe (200) (2PC)	10.9"
953-0411	JT1220 Box Down	1.90" Firestick 1 Pipe (250) (2PC)	10.75"
953-0412	JT1220 Pin Down	1.90" Firestick 1 Pipe (250) (2PC)	10.75"
953-0413	JT1220 / JT2020 Box Down	2.06" Firestick 1 Pipe (400) (1PC)	10.25"
953-0416	JT1220 / JT2020 Pin Down	2.06" Firestick 1 Pipe (400) (1PC)	11.5"
953-0214	JT2020M1 Box Down	2.375" Firestick 1 Pipe (600) (1PC)	11.25"
953-0403	JT2020M1 Pin Down	2.375" Firestick 1 Pipe (600) (2PC)	11.25"
953-0265	JT2720M1 Box Down (S-Flange)	2.375" Firestick 1 Pipe (600) (1PC)	19.3"
953-0266	JT2720M1 Box Down (S-Flange)	2.375" Firestick 1 Pipe (600) (2PC)	19.3"
953-0423	JT2720M1 Pin Down (S-Flange)	2.375" Firestick 1 Pipe (600) (2PC)	19.3"
953-0417	JT2720M1 Box Down (L-Flange)	2.375" Firestick 1 Pipe (600) (1PC)	19.3"
953-0461	JT2720M1 Box Down (L-Flange)	2.375" Firestick 1 Box (600) (2PC)	19.3"
953-0424	JT2720M1 Pin Down (L-Flange)	2.375" Firestick 1 Pipe (600) (2PC)	19.3"
953-0395	JT3020M1 Box Down (S-Flange)	2.375" Firestick 1 Pipe (600) (1PC)	27.6"
953-0462	JT3020M1 Box Down	2.375" Firestick 1 Pipe (600) (2PC)	27.6"
953-0427	JT3020M1 Pin Down (S-Flange)	2.375" Firestick 1 Pipe (600) (2PC)	27.6"
953-0391	JT7020 / JT8020 / JT100 Box Down (S-Flange)	3.5" Firestick 1 Pipe (800) (1PC)	24.3"
953-0269	JT7020 / JT8020 / JT100M1 Box Down (S-Flange)	3.5" Firestick 1 Pipe (800) (2PC)	24.3"
953-0432	JT7020 / JT8020 / JT100 Pin Down (S-Flange)	3.5" Firestick 1 Pipe (800) (2PC)	24.3"
953-0392	JT7020 / JT8020 / JT100 Box Down (L-Flange)	3.5" Firestick 1 Pipe (800) (2PC)	25.3"
953-0434	JT7020 / JT8020 / JT100 Pin Down (L-Flange)	3.5" Firestick 1 Pipe (800) (2PC)	25.3"

## Ditch Witch® Compatible Conversion Sub Savers

Part #	Fits Model	Thread Type	Overall Length
953-0454	JT922	1.66" FS1 (Box Down) Conversion Sub Saver	6"
953-0455	JT922	1.66" FS1 (Box Down) Conversion Sub Saver	7"
953-0017	JT2020M1	VM DC Sub Saver, D24x40 2-3/8" FS1 (Pin Down)	5.5"
953-0409	JT1220	1.90" FS1 (Box Down) Conversion Sub Saver	5.5"
953-0410	JT1220	1.90" FS1 (Pin Down) Conversion Sub Saver	5.5"
953-0415	JT1220 / 2020	2.06" FS1 (Pin Down) Conversion Sub Saver	6.25"
953-0421	JT2720M1 / JT3020M1	2.375" FS1 (Box Down) Conversion Sub Saver	11.25"
953-0458	JT2720M1 / 3020M1	2.375" FS1 (Pin Down) Conversion Sub Saver	11.25"
953-0430	JT7020 / 8020 / 100	3.5" FS1 (Pin Down) Conversion Sub	14.9"
953-0431	JT7020 / 8020 / 100	3.5" FS1 (Box Down) Conversion Sub	14.9"



## Astec® / Toro® / Grundodrill® / Universal

Part #	Fits Model	Thread Type
953-0331	Astec® 1416	1.9" FS1 Pin
953-0370	Astec® 3238	2-3/8" FS1 Pin
953-0351	TTTX Drive Chuck Assy	1.66 FS1 Box
953-0383	Universal 90x120	Drive Chuck 3.5" FS1 (800)
953-0384	Universal 90x120	Drive Chuck 3.5" FS1 (1000)
953-0390	Universal 100x120	Drive Chuck 3.5" FS1 (1000)

## Misc. Sub Savers

Part #	Fits Model	Thread Type
953-0378	Sub Saver	2-7/8" IF Box Pin
953-0385	Universal 100x120	Drive Chuck 3.5" HXT (FSII)
953-0386	Universal 120x180 / 160x240	DS-40 Box x Pin (4" Full Hole)
953-0387	Barbco BD100 &120 -20SC	Sub Saver 3.5" FS1 (1000)
953-0388	Barbco BD250-TK	3.5" IF Box x Pin

## Thread Lock Epoxy

Part #	Fits Model	Thread Type
954-0447	Jet-Lok 250 Thread Locker	

Vermeer® Compatible 2 Pc. Drive Chuck Assembly

Part #	Fits Model	Thread Type	Overall Length
953-0001	D7x11	1.66" Firestick	12.25"
953-0005	D10x15	1.66" Firestick	13.25"
953-0008	D16x20 / D18x22	1.90" Firestick	13.5"
953-0042	D24x26 / D20x22	2.06" Firestick	13.5"
953-0012	D24x26	2.06" Firestick	17"
953-0015	D24x40 (Below SN# 383)	2.375" Firestick	14.5"
953-0212	D24x40 (Above SN# 384)	2.375" Firestick	16"
953-0211	D24x40 Series II	2.375" Firestick	18.5"
953-0020	D33x44 / D36x50	2.375" Firestick (650)	16.5"
953-0048	D36x50 Series II	2.625" Firestick (700)	17.5"
953-0475	D40x55	2.625" Firestick (700)	18.5"
953-0023	D50x100	2.875" Firestick	17"
953-0270	D60x90	2.875" Firestick	
953-0026	D50x100 / D55 x 100 / D75x100 / D80x100	3.5" Firestick	20"
953-0195	D100x120 / D100x120 Series II / D100x140	3.5" Firestick (1000)	19.5"
953-0203	D50x100 / D55 x 100 / D75x100 / D80x100	3.5" FS1 Pin (800) Wireline	20"
953-0206	D100x120 / D100x120 Series II / D100x14	3.5" FS1 Pin (1000) Wireline	19.5"
953-0189	D33x44 / D36x50	2.375" FSII Drive Chuck Assy.	
953-0128	D100x120	3.5" FSII Drive Chuck Assy.	



Vermeer® Compatible Drive Chucks / Sub Savers

Part #	Fits Model	Thread Type	Shoulder-to-shoulder
953-0003	D7x11 / D10x14 / D10x15	1.66" Firestick (200)	4"
953-0004	D7x11 Series II / D9x13 Series II	1.66" Firestick (200)	7"
953-0010	D16x20 / D18x22	1.90" Firestick (250)	4"
953-0011	D16x20 Series II	1.90" Firestick (250)	10.14"
953-0044	D18x22 / D20x22 / D24x26	2.06" Firestick (400)	6.5"
953-0014	D24x26	2.06" Firestick (400)	8"
953-0046	D20x22 Series II	2.06" Firestick (400)	10.14"
953-0047	D20x22FX Series II (No Flange required)	2.06" Firestick (400)	10.14"
953-0473	D23x30	2-3/8" Firestick (600)	10.125"
953-0017	D24x40 ( Below serial number #383)	2.375" Firestick (600)	5.5"
953-0200	D24x40 (Serial number #384 and above)	2.375" Firestick (600)	7"
953-0019	D24x40 Series II	2.375" Firestick (600)	9.5"
953-0022	D33x44 / D36x50	2.375" Firestick (650)	7.92"
953-0018	D33x44 / D36x50	2.375" Firestick II (602)	8.375"
953-0201	D36x50	2.625" Firestick (700)	8.5"
953-0272	D36x50DR Outer Rod	2.625" Firestick (750)	9.5"
953-0474	D40x55	2.625" Firestick (700)	9.5"
953-0025	D50x100	2.875" Firestick (900)	8.3"
953-0271	D60x90	2.875" Firestick (900)	8.5"
953-0028	D50x100 / D55x100 / D75x100 / D80x100	3.5" Firestick (800)	7"
953-0197	D100x120 Series II	3.5" Firestick (1000)	7"



D16x20 Drive Chuck Assembly

## EASY TO USE. EASY TO ORDER.



*Vermeer compatible  
Collar W/ Hardfacing  
and Carbide Teeth*



*Ditch Witch compatible  
3" Octagon Collar*



*Vermeer compatible  
2" Hex Collar*

### Collars

Radius collars feature our proprietary hard-facing matrix for increased durability and wear resistance. The collar fits over the flats on the starter rod, preventing over-torquing of the threads.

#### Vermeer® Compatible Collars

Part #	Description	Fits Model
953-0057	2" Hex Collar W/ Hardfacing 1.625" Low Profile	D7x11 / D9x13 / D10x14 / D10x15
953-0058	2.5" Hex Collar W/ Hardfacing 2.125" Low Profile	D16x20 To D40x40
953-0364	2.5" Hex Collar W/ Carbide Teeth and Hardfacing	D16x20 to D40x40
953-0396	2" Hex Collar W/ Carbide Teeth and Hardfacing	D7x11 / D9x13 / D10x14 / D10x15
953-0275	RM13 Collar (QF 300 Compatible) W/ Hardfacing	D7x11 / D9x13 / D10x14 / D10x15
953-0276	RM14 Collar (QF 400 Compatible) W/ Hardfacing	D36x50 to D40x40
953-0277	RM16 Collar (QF 460 Compatible) W/ Hardfacing	D36x50 / D36x50 series II / D40x55
953-0397	RM13 Collar (QF 300 Compatible) W/ Carbide Teeth & Hardfacing	D7x11 / D9x13 / D10x14 / D10x15
953-0398	RM14 Collar (QF 400 Compatible) W/ Carbide Teeth & Hardfacing	D36x50 to D40x40
953-0399	RM16 Collar (QF 460 Compatible) W/ Carbide Teeth & Hardfacing	D36x50 / D36x50 series II / D40x55
953-0446	RM17 Collar (QF 700 Compatible) W/ Carbide Teeth & Hardfacing	D36x50DR



*D33x44  
Starter Rod*

#### Ditch Witch® Compatible Octagon Collars

Part #	Description	Fits Model
953-0070	1.5" Octagon Collar EZ2 W/ Hardfacing	JT520 / JT5
953-0071	2" Octagon Collar EZ2 W/ Hardfacing	JT920 / JT920L / JT922
953-0072	2.25" Octagon Collar EZ3 W/ Hardfacing	JT1220
953-0073	2.5" Octagon Collar EZ2 W/ Hardfacing	JT1720 / JT2020M1 / JT2720 / JT2720M1
953-0074	2.75" Octagon Collar EZ3 W/ Hardfacing	JT3020 Mach1 / AT2720M1 / AT3020M1
953-0075	3" Octagon Collar EZ2 W/ Hardfacing	JT4020 / JT4020M1
953-0258	4.125" DW EZ2 Collar W/ Hardfacing	JT7020 / JT8020 / JT100
953-0220	2.75" OCT Collar EZ2 W/ Hardfacing	JT2720M1
953-0400	3" Octagon Collar EZ2 W/ Carbide Teeth & Hardfacing	JT4020 / JT4020M1



*JT520  
EZ Connect*

# Starter Rods

Starter rods give you a non-torqued connection for safe, easy attachment of your drilling tools and reamers.

Vermeer® Compatible Starter Rods		
Part #	Description	Fits Model
953-0055	1.625" LPT Box x 200 Firestick (1.66) Box	D7x11 / D9x13 / D10x14 / D10x15
953-0051	2.125" Low Profile Box x 250 Firestick (1.90) Box	D16x20
953-0052	2.125" Low Profile Box x 400 Firestick (2.06) Box	D18x22 / D20x22 / D24x26
953-0191	2.125" Low Profile Box x 600 Firestick (2.375) Box	D24x40
953-0050	2.125" Low Profile Box x 602 Firestick II (2.375) Box	D33x44 / D36x50
953-0053	2.125" Low Profile Box x 650 Firestick (2.375) Box	D33x44 / D36x50
953-0054	2.125" Low Profile Box x 700 Firestick (2.625) Box	D36x50
953-0215	2.125" LPT Box - 2.375" FS1 Pin 22.5" OAL	24x40 / JT25
953-0264	2.125" LPT Box - 2.375" FS1 Pin 22.5" OAL	JT20 / JT25
953-0278	1.66" FS1 Box - RM13 Box	D7x11 / D10x14 / D10x15
953-0279	1.90" FS1 Box - RM14 BOX (QF 400 Compatible)	D16x20
953-0280	2.06" FS1 Box - RM14 Box (QF 400 Compatible)	D18x22 / D20x22 / D24x26
953-0281	2.375" FS1 Box - RM14 Box (QF 400 Compatible)	D24x40
953-0282	2.375" FS1 Box - RM16 Box (QF 460 Compatible)	D24x40
953-0283	2.375" FS1-650 Box - RM16 Box (QF 460 Compatible)	D36x50
953-0284	2.625" FS1-700 Box - RM16 Box (QF 460 Compatible)	D36x50
953-0285	2.625" FS1-750 Box - RM17 Box	D36x50DR Outer Rod LR
953-0438	2.625" Low Profile Box x 400 Firestick (2.06) Pin	

Ditch Witch® Compatible Quick Connect to Vermeer Pipe Starter Rods		
Part #	Description	Fits Model
953-0401	2.75" EZ Connect 2 Pin - 2.375" FS1 (600) Pipe	JT25 / JT2720M1
953-0406	1.31-6 EZ2 Pin - 1.1-5 DW Pipe Pin	JT5

Ditch Witch® Compatible Quick Connects		
Part #	Description	Fits Model
953-0059	1.21 M / 1.31 M EZ2	JT5 / JT520
953-0060	1.41 M / 1.63 M EZ2	JT920 / JT920L / JT922 / JT921
953-0061	1.3 M / 1.63 M EZ2	JT922 Coarse
953-0062	1.47 M / 1.88 M EZ3	JT1220
953-0063	1.69 M / 2.0 M EZ2	JT1720
953-0064	1.94 M / 2.0 M EZ2	JT2020
953-0065	1.94 M / 2.0 M EZ2	JT2720
953-0066	2.11 M / 2.25 M EZ2	JT2720 Mach 1
953-0067	2.11 M / 2.0 M EZ2	JT2720 Mach 1
953-0068	2.11 M / 2.25 M EZ3	JT3020 Mach 1
953-0069	2.59 M / 2.63 M EZ2	JT4020 Mach 1
953-0241	2.77 M / 2.25 M EZ3	JT2720AT / JT3020AT
953-0242	2.77 M / 2.59 M	AT2720AT / AT3020
953-0286	3.44 M / 3.5 M EZ	AT100 Lead Rod
953-0234	2.40 M / 2.63 M EZ2	JT4020
953-0287	3.27 M / 3.5 M EZ	JT7020 / JT8020 / JT100M1
953-0406	1.10 M / 1.31 M EZ2	JT5
953-0401	2.375" FS1 (600) / 2.25 M EZ2	JT25

Vermeer® Compatible Quick Connect to Ditch Witch Pipe Starter Rods		
Part #	Description	Fits Model
953-0221	2.125" LPT Box - 1.94"-4 DW Pin	JT2020
953-0253	2.125" LPT Box - 2.11"-4 DW Pin	JT2720M1 / JT3020M1

Drive Chucks & Sub Savers

STARTER RODS & QUICK CONNECTS

Adapters & Subs

Housings

Rock Tools

Bits & Blades

Reamers

Swivels

Parts & Accessories

Repairs

# THE BROADEST SELECTION. PERIOD.

If you need a sub, call Radius. **We offer more adaptors and crossover subs than anyone.** We have hundreds of subs in stock, ready to go, right now. Or we can cut a custom sub for you quick.

### Popular Connections For Your Dirt Housings & Box X Box Housings

#### Vermeer® Compatible Adaptors To Connect Your Dirt Housings & Reamers

Part #	Description	Fits Model
953-0222	1.94-4 DW Pin - 2.125" LPT Pin, 14" OAL	D16x20 thru D36x50
953-0105	2" IF Pin x 1.66" Firestick® 200 Box	D6x6 / D7x11 / D9x13 / D10x15
953-0106	2" IF Pin x 1.90" Firestick 250 Box	D16x20 / D18x22
953-0107	2" IF Pin x 2.06" Firestick 400 Box	D20x22 / D24x26
953-0108	2" IF Pin x 2.375" Firestick 600 Box	D24x40 / D24x40 II / D40x40
953-0109	2" IF Pin x 1.625" Low Profile Pin	D6x6 / D9x13 / D10x15
953-0110	2" IF Pin x 2.125" Low Profile Pin	D16x20 Thru D36x50
953-0210	2" IF Pin x 2.375" FS1 (650) Box	DD33x44 / DD36x50
953-0166	2" IF Pin x 1.90 FS1 Pin	D16x20 / D80x120
953-0343	Sub 2" IF Pin	RM16 Pin (QF 460 Compatible)
953-0289	Sub 2" IF Pin	RM13 PIN (QF 300 Compatible)
953-0290	Sub 2" IF Pin	RM14 Pin (QF 400 Compatible)
953-0111	2.375" Reg Pin x 1.66" Firestick 200 Box	D6x6 / D9x13 / D10x15
953-0112	2.375" Reg Pin x 1.90" Firestick 250 Box	D16x20 / D18x22
953-0113	2.375" Reg Pin x 2.06" Firestick 400 Box	D20x22 / 24x26
953-0114	2.375" Reg Pin x 2.375" Firestick 600 Box	D24x40 / D24x40 II / D40x40
953-0405	2.375" Reg Pin x 2.375" Firestick 600 Box	D24x40 / D24x40 II / D40x40
953-0115	2.375" Reg Pin X 2.375" Firestick 650 Box	D36x50
953-0116	2.375" Reg Pin x 2.625" Firestick 700 Box	D36x50

*“I tell anyone who asks me about tooling that Radius is who to call. They have the best tooling for the best cost and will have it in your hands in less than 36hrs. Keep up the great work guys. Radius, making it happen.”*

-Chris Spearman

Vermeer® Compatible Adapters To Connect Your Dirt Housings & Reamers, cont'd

Part #	Description	Fits Model
953-0117	2.375" Reg Pin x 1.625" Low Profile Pin	D6x6 / D9x13 / D10x15
953-0118	2.375" Reg Pin x 2.125" Low Profile Pin	D16x20 Thru D36x50
953-0231	2.375" Reg Pin x 3.5" Firestick 800 Box	D50x100 / D80x100 / D80x120 / D100x120
953-0254	2.375" Reg Pin x 2.875" Firestick 900 Box	D50x100
953-0344	2.375" Firestick I Pin x 2.125" LPT Pin	D16x20 thru D36x50
953-0435	2.375" Firestick I Pin by 1.90 Firestick Box	D16x20 / D18x22
953-0436	2.375" Firestick I Pin by 2.06 Firestick Box	D20x22 / D24x26
953-0262	Sub 2.375" Reg Pin	RM14 Pin (QF 400 Compatible)
953-0288	Sub 2.375" Reg Pin	RM16 PIN (QF 460 Compatible)
953-0354	Sub 2.375" FS1	RM14 Pin (QF 400 Compatible)
953-0355	Sub 2.375" FS1	RM16 Pin (QF 460 Compatible)
953-0119	2.875" Reg Pin x 2.375" Firestick 600 Box	D24x40 / D24x40 Series II / D40x40
953-0120	2.875" Reg Pin x 2.875" Firestick 900 Box	D50x100
953-0121	2.875" Reg Pin x 3.5" Firestick 800 Box	D50x100 / D80x100 / D80x120 / D100x120
953-0122	2.875" Reg Pin X 2.375" Firestick 650 Box	D36x50
953-0123	2.875" Reg Pin x 2.625" Firestick 700 Box	D36x50
953-0124	2.875" Reg Pin x 3.5" Firestick 1000 Box	D100x120
953-0125	2.875" Reg Pin x 2.125" Low Profile Pin	D16x20 Thru D36x50
953-0250	2.875" Reg Pin x 3.5" FS2 Box	D80x100 / D100x120 / D50x100 / D80x120
953-0291	Sub 2.875" Reg Pin	RM14 Pin (QF 400 Compatible)
953-0292	Sub 2.875" Reg Pin	RM16 Pin (QF 460 Compatible)
953-0126	3.5" IF Pin x 3.5" Firestick 800 Box	D50x100 / D80x100 / D100x120
953-0127	3.5" IF Pin x 3.5" Firestick 1000 Box	D100x120
953-0298	3.5" Reg Pin x 2.875" Firestick 900 Box	D50x100 / D60x90
953-0299	3.5" Reg Pin x 3.5" Firestick 800 Box	D50x100 / D80x100 / D100x120
953-0300	3.5" Reg Pin x 3.5" Firestick 1000 Box	D100x120
953-0293	Sub 3.5" Reg Pin	RM14 Pin (QF 400 Compatible)
953-0294	Sub 3.5" Reg Pin	RM16 Pin (QF 460 Compatible)



## Ditch Witch® Compatible Adaptors To Connect Your Dirt Housings & Reamers

Part #	Description	Fits Model
953-0302	1.66" Firestick Pin x 1.31"-6 EZ2 Box	JT520 / JT5
953-0303	1.66" Firestick Pin x 1.21"-6 Pipe Pin	JT520 / JT5
953-0301	1.66" Firestick Pin x 1.30"-5 DW Pipe Pin	JT922
953-0353	1.94-4 DW Pin x 2.0-6 EZ2 Box	JT1720 / JT1720M1 / JT2020M1 / JT2720
953-0259	1.94-4 DW Pin x 2.25-6 EZ3 Box	JT3020M1
953-0437	1.94-4 DW Pin x 1.69-6 Dw Pipe Pin	JT1720/1720M1
953-0076	2" IF Pin x 1.21"-6 Pipe Pin	JT520 / JT5
953-0077	2" IF Pin x 1.41"-6 Pipe Pin	JT920 / JT920L / JT921 / JT922
953-0078	2" IF Pin x 1.47"-4 Pipe Pin	JT1220 Mach 1
953-0079	2" IF Pin x 1.69"-6 Pipe Pin	JT1720 / JT1720 Mach 1
953-0080	2" IF Pin x 1.94"-4 Pipe Pin	JT2020 Mach 1 / JT2720
953-0081	2" IF Pin x 2.11"-4 Pipe Pin	JT2720 Mach 1 / JT3020 Mach 1
953-0082	2" IF Pin x 1.31"-6 EZ2 Box	JT520 / JT5
953-0083	2" IF Pin x 1.63"-6 EZ2 Box	JT920 / JT920L / JT921 / JT922
953-0084	2" IF Pin x 1.88"-6 EZ3 Box	JT1220 Mach 1
953-0085	2" IF Pin x 2"-6 EZ2 Box	JT1720 / JT1720 Mach 1 / JT2020 Mach 1 / JT2720
953-0086	2" IF Pin x 2.25"-6 EZ2 Box	JT2720 Mach 1
953-0087	2" IF Pin x 2.25"-6 EZ3 Box	JT3020 Mach 1
953-0088	2.375" Reg Pin x 1.69"-6 Pipe Pin	JT1720 / JT1720 Mach 1
953-0089	2.375" Reg Pin x 1.94"-4 Pipe Pin	JT2020 Mach 1 / JT2720
953-0090	2.375" Reg Pin x 2.11"-4 Pipe Pin	JT2720 Mach 1 / JT3020 Mach 1
953-0091	2.375" Reg Pin x 2.4"-4 Pipe Pin	JT4020
953-0092	2.375" Reg Pin x 2.59"-4 Pipe Pin	JT4020 Mach 1
953-0093	2.375" Reg Pin x 2"-6 EZ2 Box	JT1720 / JT1720 Mach 1 / JT2020 Mach 1 / JT2720
953-0094	2.375" Reg Pin x 2.25"-6 EZ2 Box	JT2720 Mach 1
953-0095	2.375" Reg Pin x 2.25"-6 EZ3 Box	JT3020 Mach 1
953-0096	2.375" Reg Pin x 2.63"-6 EZ2 Box	JT4020 / JT4020 Mach 1 / AT2720 / AT3020
953-0319	2.375" Reg Pin x 2.77"-4 AT Pin	2720AT / 3020AT
953-0229	2.375" Reg Pin x 1.47-4 Pin	JT1220
953-0216	SUB 2.375" Reg Pin x 1.88 EZ3 DW Box	JT1220
953-0219	SUB 2.375" Reg Pin x 1.63 EZ2 DW Box	JT920 / JT920L / JT921 / JT922
953-0236	SUB 2.375" Reg Pin x 2.59-4 DW Box	JT4020 / 4020M1

*“They have everything you need to keep the job going.  
And shipping is fast and reasonable! Highly recommend.”*

**-Allen Stapler**



## Ditch Witch® Compatible Adapters To Connect Your Dirt Housings &amp; Reamers, cont'd

Part #	Description	Fits Model
953-0097	2.875" Reg Pin x 2.11"-4 Pipe Pin	JT2720 Mach 1 / JT3020 Mach 1
953-0098	2.875" Reg Pin x 2.4"-4 Pipe Pin	JT4020
953-0099	2.875" Reg Pin x 2.59"-4 Pipe Pin	JT4020 Mach 1
953-0100	2.875" Reg Pin x 3.27"-4 Pipe Pin	JT7020 / JT8020 / JT100
953-0101	2.875" Reg Pin x 2.25"-6 EZ2 Box	JT2720 Mach 1
953-0102	2.875" Reg Pin x 2.25"-6 EZ3 Box	JT3020 Mach 1
953-0103	2.875" Reg Pin x 2.63"-6 EZ2 Box	JT4020 / JT4020 Mach 1
953-0255	2.875" Reg Pin x 3.5" FS2 Pin	JT7020 / JT8020 / JT100M1
953-0316	2.875" Reg Pin x 3.25"-4 AT Pin	JT4020AT
953-0317	2.875" Reg Pin x 3.44"-4 AT Pin	AT100
953-0318	2.875" Reg Pin x 2.77"-4 AT Pin	2720AT / 3020AT
953-0238	SUB - 2.875" Reg Pin	2.875" IF Box
953-0104	3.5" IF Pin x 3.27"-4 Pipe Pin	JT7020 / JT8020 / JT100
953-0295	3.5" Reg Pin x 2.59"-4 DW Pin	JT4020 / JT4020M1
953-0296	3.5" Reg Pin x 3.27"-4 DW Pin	JT7020 / JT8020 / JT100M1
953-0297	3.5" Reg Pin x 2.63"-6 EZ2 Box	JT4020 / JT4020M1
953-0309	3.5" Reg Pin x 2.25"-6 EZ2 Box	JT2720M1
953-0310	3.5" Reg Pin x 2.11"-4 DW Pin	JT2720M1 / JT3020M1
953-0311	3.5" Reg Pin x 2.25"-6 EZ3 Box	JT3020M1
953-0312	3.5" Reg Pin x 3.5"-6 EZ2 Box	JT7020 / JT8020 / JT100M1
953-0313	3.5" Reg Pin x 3.25"-4 AT Pin	JT4020AT
953-0314	3.5" Reg Pin x 3.44"-4 AT Pin	AT100
953-0315	3.5" Reg Pin x 2.77"-4 AT Pin	2720AT / 3020AT
953-0228	2" IF Pin x 20K Pulling Eye	
953-0223	2.375" Reg Pin x 30K Pulling Eye	
953-0459	2.375" Reg Pin x 30K Pulling Eye, 1.25" Wide Tab	
953-0248	2.875" Reg Pin x 50K Pulling Eye	
953-0460	2.875" Reg Pin x 50K Pulling Eye, 1.25" Wide Tab	
953-0358	3.5" FS1 Box	50K Pull Tab
953-0356	3.5" Reg Pin	100K Pull Tab
953-0357	3.5" IF Pin	100K Pull Tab
953-0368	3.27-4 DW Pin - 2.125" Low Profile Pin	
953-0369	2.59-4 DW Pin - 2.125" Low Profile Pin	
953-0342	6.625" Reg Box	4.5" Reg Pin
953-0359	2.875" IF Box x 2.375" FS1 Pin	(600) 4.25" OD, 6.5" S to S
953-0360	2.875" IF Box x 2.625" FS1 Pin	(700) 4.25" OD, 6.5" S to S
953-0361	2.875" IF Box x 3.5" FS1 Pin	(800) 4.25" OD, 6.5" S to S
953-0362	2.875" IF Box x 2.875" FS1 Pin	(900) 4.25" OD, 6.5" S to S
953-0363	2.875" IF Box x 3.5" FS1 Pin	(1000) 4.25" OD, 6.5" S to S
953-0374	6.625" Full Hole Box x 5.5" Full Hole Pin	5.5" Full Hole Pin, 16" S to S
953-0375	5.5" Full Hole Box x 5.5" Full Hole Pin	14" S to S, 7.5" OD
953-0263	DS40 Pin x Box 13" sh/sh	

# THE TOUGHEST, MOST VERSATILE HOUSING AVAILABLE.

Rock Housings						
Part #	Description	Diameter	Connection	Electronics	Rig Class	
951-2750	2700 Series Rock Housing	2.75"	2" IF Box x Box	15" Digitrak	6-14K	
951-2751	2700 Series Rock Housing	2.75"	2" IF Box x Box	Subsite 86 Series	6-14K	
951-3000	3000 Series Rock Housing	3.25"	2" IF Box x 3000 Radius Pin	15" Digitrak & Subsite 86 Series	15-22K	
951-3500	3500 Series Rock Housing	3.5"	2.375" Reg Box x 3500 Radius Pin	15" & 19" Digitrak & Subsite 86 Series	24-44K	
951-3510	3500 Series High Flow Rock Housing	3.5"	2.375" Reg Box x 3500 Radius Pin	15" & 19" Digitrak & Subsite 86 Series	24-44K	
951-4500	4500 Series High Flow Rock Housing	4.5"	2.875" Reg Box x 4500 Radius Pin	15" & 19" Digitrak & Subsite 86 Series	40-100K	
951-5000	5000 Series High Flow Rock Housing	5"	3.5" Reg Box x 5000 Radius Pin	15" & 19" Digitrak & Subsite 86 Series	100-250K	
951-6500	6500 Series High Flow Rock Housing	6.5"	4.5" Reg Box x 6500 Radius Pin	15" & 19" Digitrak & Subsite 86 Series	250-600K	

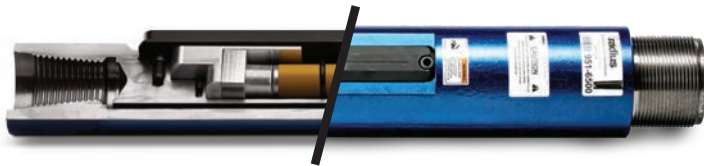

**Find Connection Subs**  
on pages 19-22.

The Radius Box x Box Sonde Housing offers unmatched flexibility in connections and tooling, perfect for medium to hard ground conditions and built with the same Radius durability in mind.

Box X Box Sonde Housings						
Part #	Description	Diameter	Connection	Electronics	Rig Class	
951-2750	2700 Series Rock Housing	2.75"	2" IF Box x Box	15" Digitrak	6-14K	
951-2751	2700 Series Rock Housing	2.75"	2" IF Box x Box	Subsite 86 Series	6-14K	
951-3020	3000 Series Rock Housing	3"	2" IF Box x Box	Subsite 86 Series	15-22K	
951-3030	3000 Series Rock Housing	3.25"	2" IF Box to Box (DCI)	Digitrak 15"	15-22K	
951-3520	3500 Series Rock Housing	3.5"	2.375" API Reg Box to Box (Subsite)	Subsite 86 Series	24-44K	
951-3530	3500 Series Rock Housing	3.5"	2.375" API Reg Box to Box (DCI)	Digitrak 15"	24-44K	
951-4520	4500 Series Rock Housing	4.25"	2.875" API Reg Box to Box (Subsite)	Subsite 86 Series	50-100K	
951-4530	4500 Series Rock Housing	4.25"	2.875" API Reg Box to Box (DCI)	Digitrak 15"	50-100K	



Only Radius offers side load housings with a patented small access window. Only drillers who have wasted hours digging their sonde out of a typical end load housing know why we do.

End Load Sonde Housings						
Part #	Description	Diameter	Connection	Electronics	Rig Class	
951-4501	End Load Housing(DCI)	4.5"	2.875" IF Box x 2.875" Reg Box	DCI 15 &19"	50-100K	
951-5001	End Load Housing(DCI)	5"	3.5" IF Box x 3.5" Reg Box	DCI 15 &19"	100-250K	
951-6501	End Load Housing(DCI)	6.5"	4.5" IF Box x 4.5' Reg Box	DCI 15 &19"	250K -600K	



## Rig Compatability

Vermeer® Compatible	
Series	Fits Model
2700	D7x11 / D7x11 Series II / D9x13 Series II / D10x14 / D10x15
3000	D16x20 / D16x20 Series II / D18x22 / D20x22 / D20x22 Series II / D20x22 FX
3500	D24x40A / D24x40 Series II / D33x44 / D36x50 / D36x50 Series II
4500	D50x100A / D60x90 / D80x100 Series II / D100x120 / D100x120 Series II / D100x140
5000	D100x120 / D100x120 Series II / D100x140
6500	D330x500 / D500x500

Ditch Witch® Compatible	
Series	Fits Model
2700	JT920 / JT920L / JT921 / JT922 / JT1220
3000	JT1220 Mach1 / JT1720 / JT1720 Mach1 / JT2020 Mach1
3500	JT25 / JT2720 / 2720M1 / AT2720 / JT3020M1 / AT3020 / JT4020 / JT4020M1 / JT4020M1
4500	JT7020 Mach1 / JT8020 Mach1 / JT100 / AT100
5000	JT100 / AT100

**Find Box x Box Sonde Housing Connections**

on pages 14-17.

**Find End Load Sonde Housing Subs**

on pages 14-17.

## 2700 SERIES CONNECTIONS

Ditch Witch® Compatible 2700 SERIES Pipe Connections				
Part #	Description	Connection To	Fits Model	
953-0076	2" IF Pin x 1.21"-6 Pipe Pin	Ditch Witch	JT5 / JT 520	
953-0077	2" IF Pin x 1.41"-6 Pipe Pin	Ditch Witch	JT 920 / JT 920L / JT 921 / JT 922	
953-0078	2" IF Pin x 1.47"-4 Pipe Pin	Ditch Witch	JT1220 Mach 1	
953-0079	2" IF Pin x 1.69"-6 Pipe Pin	Ditch Witch	JT 1720 / JT 1720 Mach 1	
953-0080	2" IF Pin x 1.94"-4 Pipe Pin	Ditch Witch	JT 2020 Mach 1 / JT 2720	
953-0081	2" IF Pin x 2.11"-4 DW Pin	Ditch Witch	JT2720M1 / JT3020M1	

Ditch Witch® Compatible 2700 SERIES EZ Connections				
Part #	Description	Connection To	Fits Model	
953-0082	2" IF Pin x 1.31"-6 EZ2 Box	Ditch Witch	JT5 / JT520	
953-0083	2" IF Pin x 1.63"-6 EZ2 Box	Ditch Witch	JT920 / JT920L / JT921 / JT922	
953-0084	2" IF Pin x 1.88"-6 EZ3 Box	Ditch Witch	JT1220 Mach 1	
953-0085	2" IF Pin x 2"-6 EZ2 Box	Ditch Witch	JT1720 / JT1720 Mach 1 / JT2020 Mach 1 / JT2720	
953-0086	2" IF Pin x 2.25"-6 EZ2 Box	Ditch Witch	JT2720 Mach 1	
953-0087	2" IF Pin x 2.25"-6 EZ3 Box	Ditch Witch	JT3020 Mach 1	

## 2700 SERIES CONNECTIONS, cont'd.

### VERMEER® Compatible 2700 SERIES Pipe Connections

Part #	Description	Connection To	Fits Model
953-0105	2" IF Pin x 1.66" Firestick 200 Box	Vermeer	D6x6 / D9x13 / D10x15 / D7x11
953-0106	2" IF Pin x 1.90" Firestick 250 Box	Vermeer	D16x20 / D18x22
953-0107	2" IF Pin x 2.06" Firestick 400 Box	Vermeer	D20x22 / D24x26
953-0108	2" IF Pin x 2.375" Firestick 600 Box	Vermeer	D24x40 / D24X40 II / D40x40
953-0166	2" IF Pin x VM 1.90" PIN (16x20)	Vermeer	D16x20 / D18x22
953-0210	2" IF Pin x 2.375" FS1-650 Pin	Vermeer	D33x44 / D36x50

### VERMEER® Compatible 2700 SERIES Quick Connects

Part #	Description	Connection To	Fits Model
953-0109	2" IF Pin x 1.625" Low Profile Pin	Vermeer	D6x6 / D7x11 / D9x13 / D10x15
953-0110	2" IF Pin x 2.125" Low Profile Pin	Vermeer	D16x20 thru D36x50

## 3000 SERIES CONNECTIONS

### 3000 SERIES Pipe Connections

Part #	Description	Connection To	Fits Model
953-0131	3" R-Box x 2.375" API REG Box	API	
953-0130	3" R-Box x DD2024 Pipe Box	Astec / Case	DD2024
953-0129	3" R-Box x 2" UNJ with Hex	Astec / Case	DD2024
953-0145	3" R-Box x Drillto 60mm Box	Drillto	ZT-18

### Ditch Witch® Compatible 3000 SERIES Pipe Connections

Part #	Description	Connection To	Fits Model
953-0185	3" R-Box x 1.69"-6 Pipe Pin	Ditch Witch	JT1720 / JT1720M1
953-0149	3" R-Box x 1.47"-4 Pipe Pin	Ditch Witch	JT1220 Mach 1
953-0153	3" R-Box x 1.94"-4 Pipe Pin	Ditch Witch	JT2020M1 / JT27420

### Ditch Witch® Compatible 3000 SERIES EZ Connections

Part #	Description	Connection To	Fits Model
953-0150	3" R-Box x 1.88"-6 EZ3 Box	Ditch Witch	JT1220 Mach 1
953-0151	3" R-Box x 2"-6 EZ2 Box	Ditch Witch	JT1720 / JT2020M1 / JT2720
953-0152	3" R-Box x 2.25"-6 EZ2 Box	Ditch Witch	JT2720M1

### VERMEER® Compatible 3000 SERIES Pipe Connections

Part #	Description	Connection To	Fits Model
953-0169	3" R-Box x 1.90" Firestick 250 Box	Vermeer	D16x20 / D18x22
953-0170	3" R-Box x 2.06" Firestick I Box	Vermeer	D20x22 / D24x26
953-0167	3" R-Box x 2.375" Firestick 600 Box	Vermeer	D24x40 / D24X40 II / D40x40

### VERMEER® Compatible 3000 SERIES Quick Connects

Part #	Description	Connection To	Fits Model
953-0168	3" R-Box x 2.125" Low Profile Pin	Vermeer	D16x20 Thru D36x50
953-0193	Radius Sub - 3.0" R-BOX	Vermeer	RM14 Pin (QF 400 Compatible)
953-0304	Radius Sub - 3.0" R-BOX	Vermeer	RM13 PIN (QF 300 Compatible)

## 3500 SERIES CONNECTIONS

3500 SERIES Pipe Connections			
Part #	Description	Connection To	Fits Model
953-0133	3.5" R-Box x 2.375" API Reg Box	API	
953-0132	3.5" R-Box x Astec Quick Connect	Astec	
953-0134	3.5" R-Box x DD3238 Astec Pipe Pin	Astec	D3238
953-0146	3.5" R-Box x Drillto 73mm Box	Drillto	ZT-25 / ZT-35
953-0135	3.5" R-Box x 2.875" IF Box	IF	DD6 / DD10
953-0235	Radius Sub - 3.5" R-Box - 2.375" IF Box	IF	
953-0328	Radius Sub - 3.5" R-Box	DWTXS 300 Box	DWTXS 300

3500 SERIES Quick Connects			
Part #	Description	Connection To	Fits Model
953-0209	3.5" R-Box x 2.5" Railhead Ramon® Pin	Railhead	Railhead Quick Connect Lead Rod
953-0306	3.5" R-Box x 2" Railhead Ramon Pin	Railhead	Railhead Quick Connect Lead Rod

Ditch Witch® Compatible 3500 SERIES Pipe Connections			
Part #	Description	Connection To	Fits Model
953-0156	3.5" R-Box x 1.94"-4 Pipe Pin	Ditch Witch	JT2020M1 / JT2720
953-0157	3.5" R-Box x 2.11"-4 Pipe Pin	Ditch Witch	JT2720M1 / JT3020M1
953-0159	3.5" R-Box x 2.40"-4 Pipe Pin	Ditch Witch	JT4020
953-0161	3.5" R-Box x 2.59"-4 Pipe Pin	Ditch Witch	JT4020M1
953-0194	3.5" R-Box x 2.59"-4 Pipe Box	Ditch Witch	JT4020M1
953-0162	3.5" R-Box x 2.77"-4 Pipe Pin	Ditch Witch	JT2720AT / JT3020AT
953-0305	3.5" R-Box x 3.25"-4 Pin	Ditch Witch	AT4020

Ditch Witch® Compatible 3500 SERIES EZ Connections			
Part #	Description	Connection To	Fits Model
953-0158	3.5" R-Box x 2"-6 E22 Box	Ditch Witch	JT2720
953-0154	3.5" R-Box x 2.25"-6 E22 Box	Ditch Witch	JT2720M1
953-0160	3.5" R-Box x 2.25"-6 E23 Box	Ditch Witch	JT3020M1
953-0155	3.5" R-Box x 2.63"-6 E22 Box	Ditch Witch	JT4020 / JT4020M1

VERMEER® Compatible 3500 SERIES Pipe Connections			
Part #	Description	Connection To	Fits Model
953-0171	3.5" R-Box x 2.375" Firestick 600 Box	Vermeer	D24x40 / D24X40 II / D40x40
953-0174	3.5" R-Box x 2.375" Firestick 650 Box	Vermeer	D36x50
953-0192	3.5" R-Box X 2.625" Firestick 700 Box	Vermeer	D36x50
953-0173	3.5" R-Box x 2.875" Firestick 900 Box	Vermeer	D50x100
953-0251	3.5" R-Box x 2.375" Firestick 600 (12" OAL)	Vermeer	D24x40 / D24x40 Series II / D40x40
953-0252	3.5" R-Box x 2.625" Firestick 700 (12" OAL)	Vermeer	D36x50 / D36x50 Series II

VERMEER® Compatible 3500 SERIES Quick Connects			
Part #	Description	Connection To	Fits Model
953-0172	3.5" R-Box x 2.125" Low Profile Pin	Vermeer	D16x20 thru D36x50
953-0249	Radius Sub - 3.5" R-BOX	Vermeer	RM14 Pin (QF 400 Compatible)
953-0307	Radius Sub - 3.5" R-BOX	Vermeer	RM16 Pin (QF 460 Compatible)

**DESIGN A CUSTOM SUB AT:**  
[www.radiushdd.com/custom-sub-builder](http://www.radiushdd.com/custom-sub-builder)  
 or call **800-892-9114**

## 4500 SERIES CONNECTIONS

4500 SERIES Pipe Connections			
Part #	Description	Connection To	Fits Model
953-0139	4.5" R-Box x 2.875" API Reg Pipe Box	API	
953-0140	4.5" R-Box x 3.5" API Reg Pipe Box	API	
953-0147	4.5" R-Box x Drillto 73mm Box	Drillto	ZT-25 / ZT-35
953-0137	4.5" R-Box x 2.875" IF Pipe Box	IF	DD6 / DD10
953-0138	4.5" R-Box x 3.5" IF Pipe Box	IF	
953-0327	Radius Sub - 4.5" R - Box	DWTXS 380 Box	DWTXS 380

Ditch Witch® Compatible 4500 SERIES Pipe Connections			
Part #	Description	Connection To	Fits Model
953-0164	4.5" R-Box x 3.27"-4 Pipe Pin	Ditch Witch	JT7020 / JT8020 / JT100
953-0165	4.5" R-Box x 2.40"-4 Pipe Pin	Ditch Witch	JT4020
953-0186	4.5" R-Box x 2.59"-4 Pipe Pin	Ditch Witch	JT4020M1
953-0187	4.5" R-Box x 3.25"-4 Pipe Pin	Ditch Witch	AT4020
953-0308	4.5" R-Box x 3.44"-4 Pipe Pin	Ditch Witch	AT100
953-0213	Radius Sub - 4.5" R-Box DW 3.27 Box	Ditch Witch	JT7020 / JT8020 / JT100

Ditch Witch® Compatible 4500 SERIES EZ Connections			
Part #	Description	Connection To	Fits Model
953-0163	4.5" R-Box x 2.63"-6 EZ2 Box	Ditch Witch	JT4020 / JT4020 Mach 1 / AT2720 / AT3020
953-0332	4.5" R-Box x 3.5"-6 EZ Box	Ditch Witch	JT7020 / JT8020 / JT100M1

VERMEER® Compatible 4500 SERIES Pipe Connections			
Part #	Description	Connection To	Fits Model
953-0177	4.5" R-Box x 2.875" Firestick 900 Box	Vermeer	D50x100
953-0175	4.5" R-Box x 3.5" Firestick 800 Box	Vermeer	D50x100
953-0176	4.5" R-Box x 3.5" Firestick II Box	Vermeer	D80x100 / 100x120
953-0239	4.5" R-Box x 3.5" Firestick 1000 Box	Vermeer	D100x120 / D100x140

## 5000 SERIES CONNECTIONS

5000 SERIES Pipe Connections			
Part #	Description	Connection To	Fits Model
953-0148	5" R-Box x 2.875" API Reg Pipe Box	API	
953-0141	5" R-Box x 3.5" API Reg Pipe Box	API	
953-0142	5" R-Box x 3.5" IF Pipe Box	IF	
953-0178	5" R-Box x 3.5" Firestick 800 Box	Vermeer	D80x100 / 100x120
953-0184	5" R-Box x 3.5" Firestick II Box	Vermeer	D80x100 / 100x120
953-0182	5" R-Box 3.5" Firestick 1000 Box	Vermeer	D100x120 / D100x140
953-0237	5" R-Box x 2.875" IF Box	IF	
953-0333	5" R-Box x 3.5"-6 EZ Box	Ditch Witch	JT7020 / JT8020 / JT100M1
953-0334	5" R-Box x 3.44"-4 DW Pipe Pin	Ditch Witch	AT100

## 6500 SERIES CONNECTIONS

6500 SERIES Pipe Connections			
Part #	Description	Connection To	Fits Model
953-0144	6" R-Box x 4.5" IF Pipe Box	IF	
953-0143	6" R-Box x 4.5" API Reg Pipe Box	REG	

## Radius Quality Rocks. Even In The Dirt.

Radius dirt housings are built to the same high standards as the rest of the Radius line. That means cheap doesn't cut it. Only radius protects the sonde with a unique lid-locking mechanism for complete and secure protection of your electronics. The replaceable tailpiece allows you to easily connect to any rig pipe or quick connect system.

### Vermeer® Compatible Dirt Housings (All Vermeer Compatible Dirt Housings run DCI Digitrak 15" sondes.)

Part #	Diameter	Bolt Pattern	Connection	Fits Model
952-0002	2.5"	6 Bolt (.5"-13)	2" IF Box Thread	D7x11 / D7x11 Series II / D9x13 Series II / D10x14 / D10x15
952-0003	2.75"	6 Bolt (.5"-13)	2" IF Box Thread	D16x20 / D16x20 Series II / D18x22 / D20x22 / D20x22 Series II / D20x22 FX
952-0124	3"	6 Bolt (.5"-13)	2.375" Firestick I Box	D16x20 / D16x20 seriesII / D18x22 D20x22 / D20x22 seriesII
952-0005	3.25"	6 Bolt (.5"-13)	2.375" API Reg Box	D24x40A / D24x40 Series II / D33x44 / D36x50 / D36x50 Series II
952-0125	3.25"	6 Bolt (.5"-13)	2.375" Firestick I Box	D24x40 / D24x40 Series II / D33x44 / D36x50
952-0006	4.25"	6 Bolt (.625"-11)	2.875" API Reg Box	D50x100A / D60x90 / D80x100 Series II / D100x120 / D100x120 Series II / D100x140

\* Runs DCI 1" x 8" mini sonde

*"Awesome service, helps out when other places can't and won't, definitely recommend using them."*

-Danny Walsh

### Ditch Witch® Compatible Dirt Housings (All Ditch Witch Compatible Dirt Housings run Subsite 86 Series Beacons.)

Part #	Diameter	Bolt Pattern	Connection	Fits Model
952-0008	2.5"	5 Bolt (12mm)	2" IF Box Thread	JT920 / JT920L / JT921 / JT922
952-0009	2.75"	5 Bolt (12mm)	2" IF Box Thread	JT920 / JT920L / JT921 / JT922 / JT1220 Mach1 / JT1720 / JT1720 Mach1 / JT2020 Mach1
952-0010	3"	5 Bolt (12mm)	1.94-4 Ditch Witch Pipe Box	JT1220 Mach1 / JT1720 / JT1720 Mach1 / JT2020 Mach1
952-0011	3.25"	6 Bolt (16mm)	2.375" API Reg Box	JT25 / JT2720 / JT2720 Mach1 / AT2720 Mach1 / JT3020 Mach1 / AT3020 Mach1 / JT4020 / JT4020 Mach1 / AT4020
952-0012	4.25"	6 Bolt (20mm)	2.875" API Reg Box	JT7020 Mach1 / JT8020 Mach1 / JT100 / AT100

\*Runs DW 88B mini beacon



**Find connection subs for your dirt housing** on pages 14-17.

Order Your Way: 800-892-9114 • RadiusHDD.com

# THE TOUGHEST, MOST DURABLE ROCK TOOLS IN THE GROUND.

Radius® is your go-to source for rock tools. We Offer a wider selection than any aftermarket supplier. And no one builds a better bit. **Controlled cutting.** **Unsurpassed durability.** Radius® the best choice for HDD Professionals.





# Rock Bits

**CARBIDE BUTTONS:** While competitive rock bits have pressed in buttons, Radius solders them in place. This allows us to use larger diameter carbides to grind cuttings more effectively so they flow more easily from the hole. It also provides better tool protection and delivers increased durability.

**CENTER AXIS CUTTING DESIGN:** Our thread-on bit design follows the centerline of the drill pipe and housing, minimizing vibration up the drill pipe and delivering greater control.

**OVERSIZED TOOTH SHANKS:** Broader at the base of the teeth, these provide added strength and durability in tough bores.

**REINFORCED SECONDARY CROWN:** Our secondary crown supports the cutting teeth in tough conditions, minimizing damage and wear to the tooth pocket.

**MORE TUNGSTEN CARBIDE SURFACE:** Experienced drillers know where the bit wears fastest. Radius builds-in added durability with precise carbide placement, extending the life of the tool and maintaining the level of control you need.

**RECESSED WATER PORTS:** While others put water ports on the cutting face where they can easily clog or wear, our recessed fluid ports are in the center of the bit to reduce the possibility of clogs and permanent bit damage.

**REAR WEAR PAD:** Radius' raised wear pad keeps the cutting teeth "in the cut" for greater control and steering. The carbide-studded pad further grinds cuttings to a more "floatable" size for easier spoil removal and a cleaner hole.

**KNOCKOUT HOLES:** No matter what size Radius bit, our knockout holes are all an inch long or less. This makes it easier for you to replace worn and broken teeth.

**STANDARD API THREADS:** Allow easy connections to both our patented rock housings and other existing sonde housings on the market.

**"OFF THE SHELF" COMPATIBILITY:** We designed Radius bits to work with "off-the-shelf" trencher teeth, making replacement more convenient and more affordable for you.

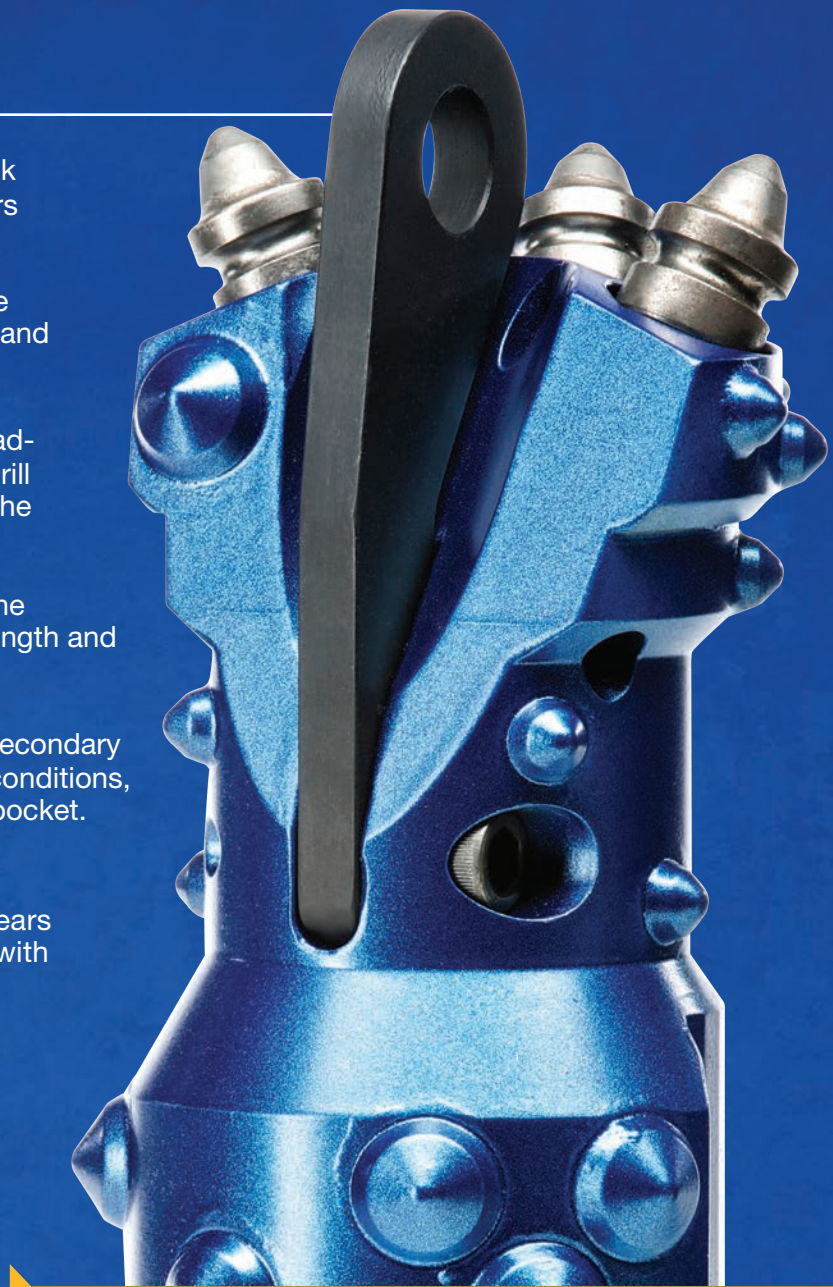

## Hot Shot Pull-Back Adaptor:



With our patented Hot Shot adaptor, you don't have to waste time removing your bit to pull back. Just bolt on a Hot Shot and you're ready to go.

Drive Chucks &  
Sub Savers

Starter Rods &  
Quick Connects

Adapters &  
Subs

Housings

ROCK TOOLS

Bits &  
Blades

Reamers

Swivels

Parts &  
Accessories

Repairs

## Rock Bits

Our most versatile tool delivers greater steering and control in any type of soil conditions while letting you navigate loose rock and solid rock conditions, too. Combined with our patented Hot Shot pull-back adaptor, it's one of the most popular bits on the market today.

Rock Bits					
Part #	Description	Thread Connection	Cut Dia	Rig Class	
950-2750	2750 Series Rock Bit	2" IF Pin	4"	7-12K	
950-3000	3000 Series Rock Bit	2" IF Pin	5"	12-22K	
950-3500	3500 Series Rock Bit	2.375" Reg Pin	6"	24-40K	
950-4500	4500 Series Rock Bit	2.875" Reg Pin	7"	50-100K	
950-5000	5000 Series Rock Bit	3.5" Reg Pin	8"	100-250K	
950-5001	5000 Series Rock Bit	3.5" IF Pin	8"	100-250K	
950-6500	6500 Series Rock Bit	4.5" Reg Pin	10"	250-600K	
950-8000	8000 Series Rock Bit	6.625" Reg Pin	14"	Over 600K	
950-8001	8000 Series Rock Bit	4.5" IF Pin	14"	Over 600K	
950-8002	8000 Series Rock Bit	4.5" Reg Pin	14"	Over 600K	
950-8003	8000 Series Rock Bit	6-5/8" Full Hole Pin	14"	Over 600K	

## Rig Compatibility

Vermeer® Compatible	
Series	Fits Model
2750	D7x11 / D7x11 Series II / D9x13 Series II / D10x14 / D10x15
3000	D16x20 / D16x20 Series II / D18x22 / D20x22 / D20x22 Series II / D20x22 FX
3500	D24x40A / D24x40 Series II / D33x44 / D36x50 / D36x50 Series II
4500	D50x100A / D60x90 / D80x100 Series II / D100x120 / D100x120 Series II / D100x140
5000	D100x120 / D100x120 Series II / D100x140
6500	D330x500 / D500x500
8000	D750x900 / D1000x900 / D1320x900

Ditch Witch® Compatible	
Series	Fits Model
2750	JT920 / JT920L / JT921 / JT922
3000	JT1220 Mach1 / JT1720 / JT1720 Mach1 / JT2020 Mach1
3500	JT25 / JT2720 / 2720M1 / AT2720 / JT3020M1 / AT3020 / JT4020 / JT4020M1 / AT4020
4500	JT7020 Mach1 / JT8020 Mach1 / JT100 / AT100
5000	JT100 / AT100

American Auger® Compatible	
Series	Fits Model
4500	DD-6
5000	DD-10 / DD-220 / DD-220T
6500	DD-440 / DD-440T
8000	DD-625 / DD-1100 / DD-1100RS



## Rock Bit Teeth

We designed our bits to use “off-the-shelf” trencher teeth, which are easier for you to find if you’re in a pinch. That’s not only more convenient, it’s more affordable for you, too.

Rock Bit Teeth	
Part #	Description
954-0282	2750 Series Rock Tooth (Domed)
954-0244	2750 Radius Rock Bit Tooth
954-0237	3000 Radius Rock Bit Tooth
954-0383	3000 Radius Rock Bit Tooth (C Clip Style)
954-0238	3000 Radius Rock Tooth (Domed)
954-0241	3500 Radius Rock Bit Tooth
954-0384	3500 Series Rock Tooth (Frac – Long)
954-0242	3500 Radius Rock Bit Tooth (Domed)
954-0243	4500 Radius Rock Bit Tooth
954-0239	5000 Radius Rock Bit Tooth
954-0392	5000 Radius Rock Bit Tooth (Large)
954-0240	6500 Radius Rock Bit Tooth
954-0245	8000 for BRUTUS Tooth with Hardfacing



2750 Radius  
Rock Bit Tooth



3000 Radius  
Rock Bit Tooth



3500 Radius  
Rock Bit Tooth



3500 Radius  
Rock Bit Tooth (Domed)



4500 Radius  
Rock Bit Tooth



5000 Radius  
Rock Bit Tooth



6500 Radius  
Rock Bit Tooth



8000 for Brutus  
with Hardfacing

# OUR NEWEST GAME CHANGER WRAPPED AROUND OUR ORIGINAL GAME CHANGER.



## Small exit pit, Over-Bit.

Just like the “pull back adapter” before it, the Radius team has worked with a number of small bore contractors to develop the **new patent-pending Over-Bit Reamer**. And it’s a game changer.

Since the reamer simply installs **over your Radius Rock Bit**, the required **exit pit size is minimal with no need to disconnect or even expose the sonde housing and lead rod**, allowing you to monitor your pull back. The Over-Bit Reamer is perfect for fiber projects and crowded easements.

[tools.radiushdd.com/over-bit](https://tools.radiushdd.com/over-bit)

### DRILLING TO REAMING

How big of an exit pit do you need?

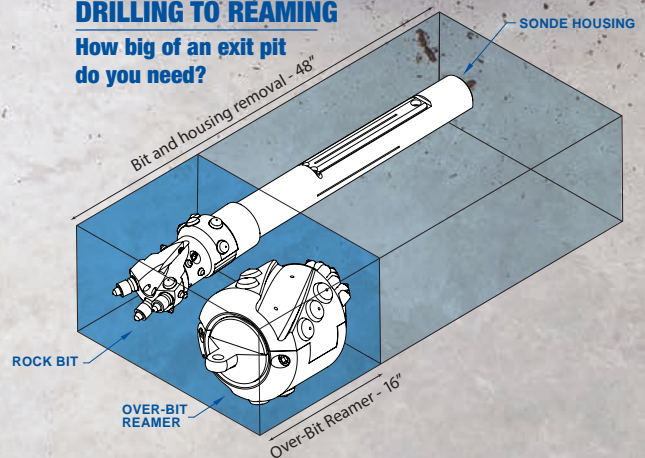

## The All New Radius® Over-Bit Reamer

The new Radius Overbit Reamer eliminates completely the need to remove pilot tools to attach a reamer. Designed for fiber and small bore contractors, the Overbit Reamer simply attaches over the pilot bit and secures with one bolt. It offers the simplicity your crews have been looking for and perfect in small exit pits - No collars, no wrenches or tongs. With the pilot tool attached the sonde can be used to locate through tight easements or intersects. Designed exclusively for 2700 and 3500 series Radius rock bit.



### Radius Over-Bit Reamer

Part #	Description
956-0496	6" Radius Over-Bit Reamer Fits 2700 Series
956-0497	8" Radius Over-Bit Reamer Fits 3000 Series
SPL-0020	2750 Series Rock Bit & 6" Over-Bit Bundle
SPL-0021	3000 Series Rock Bit & 8" Over-Bit Bundle

## Tricone Bits

Radius HDD offers the "Focus" tricone bit line in both Milltooth and TCI cutting structures, delivering quality to contractors at the right price. The Milltooth bit is designed for soft rock formation less than 10,000 psi such as sand, clay stone and soft shale. The TCI bit is designed for medium to medium hard rock formation 10,000 to 28,000 psi such as shale, limestone, granite. Bits feature sealed bearings, cone nose protection, carbide insert gauge protection and carbide nozzles to protect from abrasive drilling and assist fluid control.

### Sealed Bearing Tricones

Part #	Size	Style	IADC	Thread Connection
950-1023	5.5" Tricone	TCI	527 (8000-28000 PSI Rock)	2.875" Reg Pin
950-1009	5.5" Tricone	Mill Tooth	117 (0-5000 PSI Rock)	2.875" Reg Pin
950-1044	5.875" Tricone	TCI	527 (8000-28000 PSI Rock)	3.5" Reg Pin
950-1008	6" Tricone	TCI	527 (8000-28000 PSI Rock)	2.875" Reg Pin
950-1010	6" Tricone	Mill Tooth	117 (0-5000 PSI Rock)	3.5" Reg Pin
950-1011	6.5" Tricone	TCI	527 (8000-28000 PSI Rock)	3.5" Reg Pin
950-1018	6.75" Tricone	Mill Tooth	117 (0-5000 PSI Rock)	3.5" Reg Pin
950-1012	6.75" Tricone	TCI	527 (8000-28000 PSI Rock)	3.5" Reg Pin
950-1013	7.875" Tricone	TCI	527 (8000-28000 PSI Rock)	4.5" Reg Pin
950-1019	7.875" Tricone	Mill Tooth	117 (0-5000 PSI Rock)	4.5" Reg Pin

### Open Bearing Tricones

Part #	Size	Style	IADC	Thread Connection
950-1035	5.5" Tricone	Mill Tooth	322 (7500-14000 PSI Rock)	2.875" Reg Pin
950-1036	6" Tricone	Mill Tooth	321 (7500-14000 PSI Rock)	3.5" Reg Pin
950-1060	6.125" Tricone	Mill Tooth	321 (7500-14000 PSI Rock)	2.875" Reg Pin
950-1054	6.75" Tricone	TCI	522 (8000-28000 PSI Rock)	3.5" Reg Pin



*TCI Tricone Bits*



*Milltooth Tricone Bits*

## PDC Bits

The Radius PDC bits built with American steel and American made cutters for a peace of mind quality investment. We kept horizontal use in mind, providing balanced machining, elongated flutes, side gauge protection where it matters and cutter placement to accelerate drilling softer solid formation such as compressed sand, mudstone, claystone and limestone.

PDC Bits			
Part #	Size	Blade Count	Thread Connection
950-1038	3.875" PDC	5-Blade	2.375" Reg Pin
950-1046	4" PDC	5-Blade	2.375" Reg Pin
950-1047	4.5" PDC	5-Blade	2.375" Reg Pin
950-1048	5" PDC	5-Blade	2.875" Reg Pin
950-1045	5.125" PDC	5-Blade	2.875" Reg Pin
950-1049	5.5" PDC	5-Blade	2.875" Reg Pin
950-1050	6" PDC	5-Blade	3.5" Reg Pin
950-1039	7.875" PDC	5-Blade	4.5" Reg Pin



Radius PDC Bits			
Part #	Size	Blade Count	Thread Connection
950-1025	5.5" PDC w/ nozzles	5-Blade	2.875" Reg Pin
950-1063	5.625" PDC	3-Blade	2.875" Reg Pin
950-1051	6.5" PDC	5-Blade	3.5" Reg Pin



Radius Steerable PDC Bits		
Part #	Description	Thread Connection
950-3506	3.5 Series	2-3/8" Reg Pin



**Find PDC Repair info**

on page 55.

## Cobble Bits

The Radius cobble bit is designed to maximize productivity and durability in cobble and loose rock conditions. With its carbide face and scooped profile, this pilot offers stable cutting action, but also provides improved navigational characteristics. Cobble is never easy – this bit changes the game.

### Cobble Bits

Part #	Description	Thread Connection	Cut	Rig Class
950-3505	3500 Series Cobble Bit	2.375" Reg Pin	5"	24-40K
950-4505	4500 Series Cobble Bit	2.875" Reg Pin	6"	40-100K
950-5005	5000 Series Cobble Bit	3.5" Reg Pin	7"	100-250K

## Rig Compatability

### Vermeer® Compatible

Series	Fits Model
3500	D2440A / D24x40 series II / D33x44 / D36x50 / D35x50 series II
4500	D50x100 / D60x90 / D80x100 Series II / D100x120 / D100x120 Series II / D100x140
5000	D100x120 / D100x120 Series II / D100x140

### Ditch Witch® Compatible

Series	Fits Model
3500	JT25 / JT2720 / JT2720 M1 / AT2720 / JT3020M1 AT3020 / JT4020 / JT4020M1 / AT4020
4500	JT7020M1 / JT8020M1 / JT100 / AT100
5000	JT100 / AT100

### American Auger® Compatible

Series	Fits Model
4500	DD-6
5000	DD-10/ DD-220 / DD-220T



*“They are the best in the business, they have awesome customer support and are fabrication masters and will do what it takes to get your job site moving.”*

-Brad Brown

## Single Roller Cone Bit

Our proprietary design delivers better steering than any competitive bit, while a carbide-covered steering plate and additional carbide on the face delivers better grinding capabilities for your solid rock jobs.

### Single Roller Cone Bits

Part #	Description	Thread Connection	Cut	Rig Class
950-3001	3000 Single Roller Cone Bit	2" IF Pin	5"	14-24K
950-3501	3500 Single Roller Cone Bit	2.375" Reg Pin	6"	24-40K
950-4501	4500 Single Roller Cone Bit	2.875" Reg Pin	7"	40-100K
950-5003	5000 Single Roller Cone Bit	3.5" Reg Pin	7"	100-250K

## Rig Compatibility

### Vermeer® Compatible

Series	Fits Model
3000	D16x20 / D16x20 Series II / D18x22 / D20x22 / D20x22 Series II / D20x22 FX / D24x26
3500	D24x40A / D24x40 Series II / D33x44 / D36x50 / D36x50 Series II
4500	D50x100A / D60x90 / D80x100 Series II / D100x120 / D100x120 Series II / D100x140
5000	D100x120 / D100x120 Series II / D100x140

### Ditch Witch® Compatible

Series	Fits Model
3000	JT1220 Mach1 / JT1720 / JT1720 Mach1 / JT2020 Mach1
3500	JT25 / JT2720 / 2720M1 / AT2720 / JT3020M1 / AT3020 / JT4020 / JT4020M1
4500	JT7020 Mach1 / JT8020 Mach1 / JT100 / AT100

### American Auger® Compatible

Series	Fits Model
4500	DD-6 / DD-10 / DD-220 / DD-220T



## Thread-On Blade Adaptor

Make your rock housing even more versatile with our thread-on dirt blade adaptor. The replaceable jetting nozzle minimizes clogging and maximizes jetting pressure.

### Thread-On Blade Adaptors

Part #	Description	Thread Connection
952-0092	Ditch Witch 5 Bolt (12mm)	2" IF Pin - 2.75" dia
952-0085	Ditch Witch 5 Bolt (12mm)	2" IF Pin - 3" dia
952-0086	Ditch Witch 5 Bolt (12mm)	2.375" Reg Pin
952-0087	Ditch Witch 6 Bolt (16mm)	2.375" Reg Pin
952-0088	Ditch Witch 6 Bolt (20mm)	2.875" Reg Pin
952-0096	Ditch Witch 6 Bolt (20mm)	3.5" Reg Pin
952-0126	Ditch Witch 6 Bolt (20mm)	4.5" Reg Pin
952-0093	Vermeer 6 Bolt (.5"-13)	2" IF Pin - 2.75" dia
952-0082	Vermeer 6 Bolt (.5"-13)	2" IF Pin - 3" dia
952-0083	Vermeer 6 Bolt (.5"-13)	2.375" Reg Pin
952-0084	Vermeer 6 Bolt (.625"-11)	2.875" Reg Pin
952-0089	Vermeer 6 Bolt (.625"-11)	3.5" Reg Pin
952-0090	Vermeer 6 Bolt (.625"-11)	3.5" IF Pin
952-0091	Vermeer 6 Bolt (.625"-11)	4.5" Reg Pin
952-0137	Vermeer 6 Bolt (.75-10)	3.5" Reg Pin
952-0138	Vermeer 6 Bolt (.75-10)	4.5" Reg Pin





# radius® SWAG

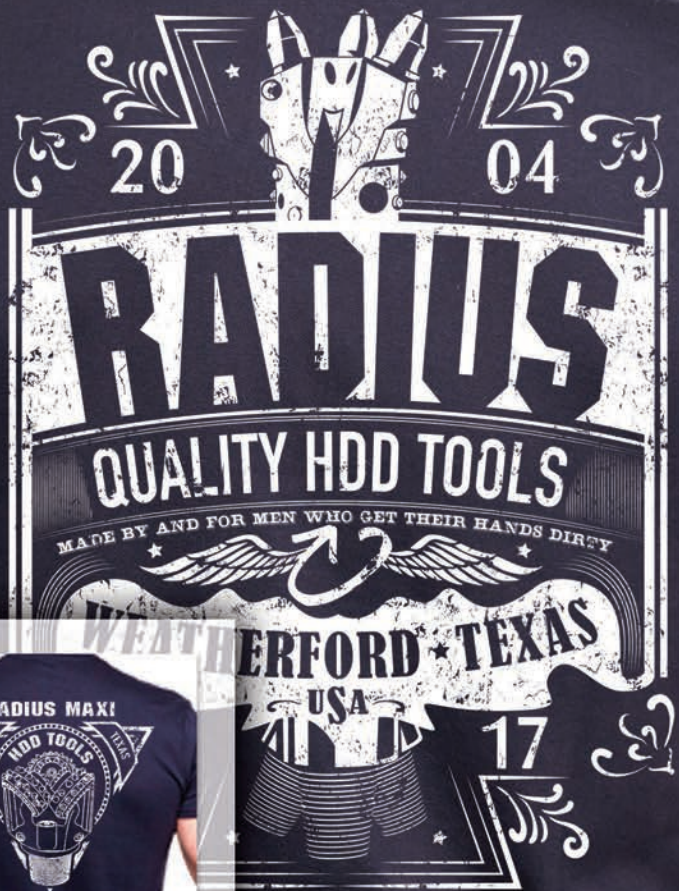

You asked for it, and Radius® made it happen!  
Head over to [radiushdd.com](http://radiushdd.com) to stock up on some  
**kick-ass Radius HDD swag** for you and the crew.



Drive Chucks &  
Sub Savers

Starter Rods &  
Quick Connects

Adapters &  
Subs

Housings

ROCK TOOLS

Bits &  
Blades

Reamers

Swivels

Parts &  
Accessories

Repairs

# TACKLE ANY CONDITION WITH A RADIUS BLADE

Our field-tested, HDD Pro-proven designs give you a downhole advantage in durability and performance.

**Jagger** For hard rock, hardened compact soil/gravel.

- Carbide teeth welded on cutting face for more durability and better cutting performance.
- Chunky carbide along wear edges provides protection to extend blade life.

**Vermeer® Compatible Jagger Blade**

Part #	Bolt Pattern	Width	Thickness
952-0099	6 Bolt (.5"-13)	3.5"	.625"
952-0017	6 Bolt (.5"-13)	4"	.75"
952-0018	6 Bolt (.5"-13)	5"	.75"
952-0105	6 Bolt (.625"-11)	5"	1"
952-0039	6 Bolt (.625"-11)	6"	1"
952-0019	6 Bolt (.5"-13)	6.5"	.75"
952-0020	6 Bolt (.625"-11)	8"	1"
952-0104	6 Bolt (.75"-10)	8"	1"
952-0146	6 Bolt (.625"-11)	10"	1"
952-0148	6 Bolt (.75"-10)	10"	1"

**Ditch Witch® Compatible Jagger Blade**

Part #	Bolt Pattern	Width	Thickness
952-0129	3 Bolt (12mm)	3"	.75"
952-0100	5 Bolt (12mm)	3.5"	.625"
952-0051	5 Bolt (12mm)	4"	.75"
952-0101	6 Bolt (16mm)	4.5"	.75"
952-0052	5 Bolt (12mm)	5"	.75"
952-0067	6 Bolt (16mm)	5"	.75"
952-0102	6 Bolt (20mm)	5"	1"
952-0068	6 Bolt (20mm)	6"	1"
952-0103	6 Bolt (20mm)	8"	1"
952-0149	6 Bolt (20mm)	10"	1"



*“Always on point and excellent tooling and great guys and gals always willing to help.”*

-James Kennedy

## Steep Taper Jagger For hard rock, hardened compact soil/gravel.

- Designed for directional pushes with a leading center point for easier penetration and quicker steering.
- Carbide teeth welded on cutting face for more durability and better cutting performance.
- Chunky carbide protection along wear edges to extend blade life.
- Clipped rear corner design to minimize drag.

### Vermeer® Compatible Steep Taper Jagger Blade

Part #	Bolt Pattern	Width	Thickness
952-0106	6 Bolt (.5"-13)	3.5"	.75"
952-0021	6 Bolt (.5"-13)	4"	.75"
952-0022	6 Bolt (.5"-13)	5"	.75"
952-0107	6 Bolt (.625"-11)	5"	1"
952-0098	6 Bolt (.625"-11)	6"	1"
952-0178	6 Bolt (.75"-10)	6"	1"
952-0130	6 Bolt (.625"-11)	8"	1"
952-0147	6 Bolt (.75"-10)	7"	1"
952-0108	6 Bolt (.75"-10)	8"	1"

### Ditch Witch® Compatible Steep Taper Jagger Blade

Part #	Bolt Pattern	Width	Thickness
952-0053	5 Bolt (12mm)	4"	.75"
952-0109	6 Bolt (16mm)	4"	.75"
952-0069	6 Bolt (16mm)	5"	.75"
952-0110	6 Bolt (20mm)	5"	1"
952-0145	5 Bolt (12mm)	5"	.75"
952-0094	6 Bolt (20mm)	6"	1"
952-0111	6 Bolt (20mm)	8"	1"



## Monster For hard, rocky soil conditions such as caliche, sandstone.

- Aggressive tooth placement with carbide points for superior fracturing and penetration in extreme conditions.
- Carbide-protected wear edges for long-lasting durability.

### Vermeer® Compatible Monster Blade

Part #	Bolt Pattern	Width	Thickness
952-0023	6 Bolt (.5"-13)	3.5"	.75"
952-0024	6 Bolt (.5"-13)	4"	.75"
952-0025	6 Bolt (.5"-13)	5"	.75"
952-0040	6 Bolt (.625"-11)	5"	1"
952-0041	6 Bolt (.625"-11)	6"	1"
952-0131	6 Bolt (.625"-11)	8"	1"
952-0115	6 Bolt (.75"-10)	8"	1"

### Ditch Witch® Compatible Monster Blade

Part #	Bolt Pattern	Width	Thickness
952-0054	5 Bolt (12mm)	3.5"	.75"
952-0055	5 Bolt (12mm)	4"	.75"
952-0070	6 Bolt (16mm)	4"	.75"
952-0056	5 Bolt (12mm)	5"	.75"
952-0071	6 Bolt (16mm)	5"	.75"
952-0117	6 Bolt (20mm)	6"	1"
952-0118	6 Bolt (20mm)	8"	1"



## 180° For rocky and abrasive soil conditions.

- 180° cutting-edge design for smoother rotation and cutting performance.
- Carbide buttons for increased cutting action in tough conditions.

### Vermeer® Compatible 180° Blade

Part #	Bolt Pattern	Width	Thickness
952-0013	6 Bolt (.5"-13)	3.5"	.75"
952-0014	6 Bolt (.5"-13)	4"	.75"
952-0037	6 Bolt (.5"-13)	4.5"	0.75"
952-0015	6 Bolt (.5"-13)	5"	.75"
952-0036	6 Bolt (.625"-11)	5"	1"
952-0016	6 Bolt (.5"-13)	6"	.75"
952-0038	6 Bolt (.625"-11)	6"	1"
952-0132	6 Bolt (.625"-11)	8"	1"
952-0113	6 Bolt (.75"-10)	8"	1"
952-0167	5 Bolt (3/8" - 16)	3.5"	.75"

### Ditch Witch® Compatible 180° Blade

Part #	Bolt Pattern	Width	Thickness
952-0048	5 Bolt (12mm)	3.5"	.75"
952-0049	5 Bolt (12mm)	4"	.75"
952-0063	6 Bolt (16mm)	4"	.75"
952-0050	5 Bolt (12mm)	5"	.75"
952-0064	6 Bolt (16mm)	5"	.75"
952-0065	6 Bolt (20mm)	5"	1"
952-0066	6 Bolt (20mm)	6"	1"
952-0114	6 Bolt (20mm)	8"	1"



## Rubble For sand and sandy loams.

- An all-purpose design for soft, but abrasive, conditions.
- Rubble of carbide applied to cutting edge for greater penetration and longer blade life.

### Vermeer® Compatible Rubble Blade

Part #	Bolt Pattern	Width	Thickness
952-0168	5 Bolt (3/8"-16)	3.5"	.75"
952-0169	5 Bolt (3/8"-16)	2.5"	.5"
952-0033	6 Bolt (.5"-13)	3.5"	.75"
952-0034	6 Bolt (.5"-13)	4"	.75"
952-0035	6 Bolt (.5"-13)	5"	.75"
952-0046	6 Bolt (.625"-11)	5"	1"
952-0047	6 Bolt (.625"-11)	6"	1"
952-0140	6 Bolt (.75"-10)	6"	1"
952-0119	6 Bolt (.75"-10)	8"	1"
952-0133	6 Bolt (.625"-11)	8"	1"
952-0139	6 Bolt (.625"-11)	10"	1"
952-0141	6 Bolt (.75"-10)	10"	1"
952-0142	6 Bolt (.75"-10)	12"	1"
952-0061	5 Bolt (12mm)	3"	.75"
952-0062	5 Bolt (12mm)	4"	.75"
952-0078	6 Bolt (16mm)	4"	.75"
952-0079	6 Bolt (16mm)	5"	.75"
952-0080	6 Bolt (20mm)	5"	1"
952-0081	6 Bolt (20mm)	6"	1"
952-0120	6 Bolt (20mm)	8"	1"
952-0143	6 Bolt (20mm)	10"	1"



## Steep Taper Rubble For sand and sandy loams.

- Designed for directional pushes with a leading center point for easier penetration and quicker steering.
- Chunky carbide protection along wear edges to extend blade life.
- Clipped rear corner design to minimize drag.

### Vermeer® Compatible Steep Taper Rubble Blade

Part #	Bolt Pattern	Width	Thickness
952-0026	6 Bolt (.5"-13)	3.5"	.75"
952-0027	6 Bolt (.5"-13)	4"	.75"
952-0028	6 Bolt (.5"-13)	5"	.75"
952-0042	6 Bolt (.625"-11)	5"	1"
952-0029	6 Bolt (.5"-13)	6"	.75"
952-0043	6 Bolt (.625"-11)	6"	1"
952-0134	6 Bolt (.625"-11)	8"	1"
952-0121	6 Bolt (.75"-10)	8"	1"

### Ditch Witch® Compatible Steep Taper Rubble Blade

Part #	Bolt Pattern	Width	Thickness
952-0127	3 Bolt (12mm)	2.5"	.75"
952-0057	5 Bolt (12mm)	3"	.75"
952-0058	5 Bolt (12mm)	4"	.75"
952-0072	6 Bolt (16mm)	4"	.75"
952-0095	6 Bolt (16mm)	5"	.75"
952-0073	6 Bolt (20mm)	5"	1"
952-0122	6 Bolt (20mm)	6"	1"
952-0123	6 Bolt (20mm)	8"	1"



## Razor Blade

- Taper Design assists with Steering and penetration rate.
- Aggressive tooth placement with carbide points for superior fracturing and penetration in extreme conditions.
- Carbide-protected wear edges for long-lasting durability.

### Vermeer® Compatible Razor Blade

Part #	Bolt Pattern	Width	Thickness
952-0174	6 Bolt (.5"-13)	3.5"	.75"
952-0175	6 Bolt (.5"-13)	4"	.75"
952-0176	6 Bolt (.5"-13)	5"	.75"

### Ditch Witch® Compatible Razor Blade

Part #	Bolt Pattern	Width	Thickness
952-0170	5 Bolt (12mm)	3.5"	.75"
952-0171	5 Bolt (12mm)	4"	.75"
952-0172	6 Bolt (16mm)	4"	.75"
952-0173	6 Bolt (16mm)	5"	.75"
952-0177	5 Bolt (12mm)	5"	.75"



## Power Point

- Taper design assists with steering and penetration rate in loose cobble and gravel conditions.
- Carbide buttons for increased cutting action in tough conditions.
- Carbide protection along edges for longer blade life.

### Vermeer® Compatible Power Point

Part #	Bolt Pattern	Width	Thickness
952-0150	6 Bolt (.5"-13)	3.5"	.75"
952-0151	6 Bolt (.5"-13)	4"	.75"
952-0152	6 Bolt (.5"-13)	4.5"	.75"
952-0153	6 Bolt (.5"-13)	5"	.75"
952-0154	6 Bolt (.625"-11)	6"	.75"
952-0155	6 Bolt (.5"-13)	6"	.75"

### Ditch Witch® Compatible Power Point

Part #	Bolt Pattern	Width	Thickness
952-0156	5 Bolt (12mm)	3.5"	.75"
952-0157	5 Bolt (12mm)	4"	.75"
952-0158	6 Bolt (16mm)	4"	.75"
952-0159	6 Bolt (16mm)	5"	.75"
952-0160	6 Bolt (16mm)	4.5"	.75"
952-0161	6 Bolt (16mm)	6"	.75"



## Steep Taper Power Point Blade For loose cobble and gravel.

- Designed for directional pushes with a leading center point for easier penetration and quicker steering.
- Carbide buttons for increased cutting action in tough conditions.
- Carbide protection along edges for longer blade life.
- Clipped rear corner design to minimize drag.

### Vermeer® Compatible Steep Tip Power Point Blade

Part #	Bolt Pattern	Width	Thickness
952-0179	6 Bolt (.5"-13)	3.5"	.75"
952-0180	6 Bolt (.5"-13)	4"	.75"
952-0181	6 Bolt (.5"-13)	4.5"	.75"
952-0182	6 Bolt (.5"-13)	5"	.75"

### Ditch Witch® Compatible Steep Tip Power Point Blade

Part #	Bolt Pattern	Width	Thickness
952-0186	5 Bolt (12mm)	3.5"	.75"
952-0187	5 Bolt (12mm)	4"	.75"
952-0183	6 Bolt (16mm)	4"	.75"
952-0188	5 Bolt (12mm)	4.5"	.75"
952-0184	6 Bolt (16mm)	4.5"	.75"
952-0189	5 Bolt (12mm)	5"	.75"
952-0185	6 Bolt (16mm)	5"	.75"



# 90 DRILLS. 1 LOCATION.



At MTI®, we have the largest on-site inventory of quality used drills in the world. How do we know? Every one of those drills goes through our meticulous 80-point inspection. Once initial issues are resolved by our highly trained mechanics, it faces harsh conditions at our on-site test facility to identify any additional areas of concern. Our goal is to find problems here so you don't out there. That's our RE-HDD process. We are taking the risk out of buying used. Come see and operate our entire selection of used HDD equipment at our Florida yard.



**METICULOUS INSPECTIONS  
HIGHLY TRAINED MECHANICS  
ON-SITE TEST FACILITY**

**VISIT [MTIEQUIP.COM](http://MTIEQUIP.COM) OR CALL 844.MTI.EQUIP**



Copyright © 2015 MTI Equipment



A Charles Machine Works Company

Drive Chucks & Side Savers

Starter Rods & Quick Connects

Adapters & Subs

Housings

Rock Tools

**BITS & BLADES**

Reamers

Swivels

Parts & Accessories

Repairs



Reamers

# **REAMERS** **NOBODY BUILDS A** **BETTER REAMER,** **NO MATTER WHAT THEY CLAIM.**

Packed with the features you need and that famous Radius ruggedness, our reamers are ready to tackle any condition you face — getting the job done right.



## Barrel Reamer

Designed with thick-walled structural steel and internally gusseted for unmatched strength and durability.

- Designed to operate as an effective compaction reamer in softer conditions
- An ideal centralizer for larger diameter projects
- Available in chambered and non-chambered designed for varying projects and weight preference.

Barrel Reamers				
Part #	Cutting Size	Connection	Shaft Diameter	
956-0181	8"	2.375" Reg Box x Box	3.5"	
956-0182	10"	2.375" Reg Box x Box	3.5"	
956-0183	12"	2.375" Reg Box x Box	3.5"	
956-0385	12"	2.875" Reg Box x Box	4.25"	
956-0386	16"	2.875" Reg Box x Box	4.25"	
956-0387	18"	2.875" Reg Box x Box	4.25"	
956-0388	20"	2.875" Reg Box x Box	4.25"	
956-0180	24"	2.875" Reg Box x Box	4.25"	
956-0390	16"	3.5" Reg Box x Box	5"	
956-0391	18"	3.5" Reg Box x Box	5"	
956-0392	20"	3.5" Reg Box x Box	5"	
956-0393	24"	3.5" Reg Box x Box	5"	
956-0394	30"	3.5" Reg Box x Box	5"	
956-0395	36"	3.5" Reg Box x Box	5"	



## Hole Openers

Radius designs and builds some of the most durable hole openers available. Engineered to maximize productivity in the most difficult solid and fractured rock conditions.

- Hole openers are built to your needs with our exacting standards
- 16" to 48" hole openers are commonly stocked to for same day shipping when time is critical
- Manufactured with new or rerun cones offers economic options
- Field proven design and performance

Hole Openers			
Part #	Cutting Size	Qty & Size of Cones	Connection / Shaft Diameter
956-0372	10"	4 - 6.25" TCI Cones	2.375" Reg Box x Box / 3.5"
956-0373	12"	4 - 7.875" TCI Cones	2.375" Reg Box x Box / 3.5"
956-0374	14"	4 - 8.75" TCI Cones	2.375" Reg Box x Box / 3.5"
956-0375	16"	5 - 8.75" TCI Cones	2.375" Reg Box x Box / 3.5"
956-0420	18"	6 - 8.75" TCI Cones	2.375" Reg Box x Box / 3.5"
956-0421	12"	4 - 7.875" TCI Cones	2.875" Reg Box x Box / 4.25"
956-0376	14"	4 - 8.75" TCI Cones	2.875" Reg Box x Box / 4.25"
956-0377	16"	5 - 8.75" TCI Cones	2.875" Reg Box x Box / 4.25"
956-0378	18"	6 - 8.75" TCI Cones	2.875" Reg Box x Box / 4.25"
956-0379	20"	5 - 12.25" TCI Cones	2.875" Reg Box x Box / 4.25"
956-0380	24"	5 - 12.25" TCI Cones	2.875" Reg Box x Box / 4.25"
956-0381	16"	5 - 8.75" TCI Cones	3.5" Reg Box x Box / 5"
956-0382	18"	6 - 8.75" TCI Cones	3.5" Reg Box x Box / 5"
956-0383	20"	4 - 12.25" TCI Cones	3.5" Reg Box x Box / 5"
956-0384	24"	5 - 12.25" TCI Cones	3.5" Reg Box x Box / 5"
956-0423	30"	6 - 12.25" TCI Cones	3.5" Reg Box x Box / 5"



Drive Chucks & Sub Savers

Starter Rods & Quick Connects

Adapters & Subs

Housings

Rock Tools

Bits & Blades

**REAMERS**

Swivels

Parts & Accessories

Repairs

## Fly Cutter Reamer For sand with cobbles, sandstone and hardpan.

- Maximum number of cutters available on the market today.
- Carbide-tipped teeth for better cutting performance.
- Rear-facing teeth for easy push-backs.
- Open, tapered design reduces torque load needed and mixes spoils with drilling mud.

Fly Cutter Reamers			
Part #	Cutting Size	Connection	Shaft Diameter
956-0081	8"	2" IF Box x Box	2.75"
956-0082	10"	2" IF Box x Box	2.75"
956-0083	12"	2" IF Box x Box	2.75"
956-0084	14"	2" IF Box x Box	2.75"
956-0085	16"	2" IF Box x Box	2.75"
956-0086	18"	2" IF Box x Box	2.75"
956-0087	8"	2.375" Reg Box x Box	3.5"
956-0088	10"	2.375" Reg Box x Box	3.5"
956-0089	12"	2.375" Reg Box x Box	3.5"
956-0090	14"	2.375" Reg Box x Box	3.5"
956-0091	16"	2.375" Reg Box x Box	3.5"
956-0092	18"	2.375" Reg Box x Box	3.5"
956-0093	20"	2.375" Reg Box x Box	3.5"
956-0094	24"	2.375" Reg Box x Box	3.5"
956-0095	28"	2.375" Reg Box x Box	3.5"
956-0096	32"	2.375" Reg Box x Box	3.5"
956-0097	36"	2.375" Reg Box x Box	3.5"
956-0172	30"	2.375" Reg Box x Box	3.50"
956-0098	10"	2.875" Reg Box to Box	4.25"
956-0099	12"	2.875" Reg Box to Box	4.25"
956-0100	14"	2.875" Reg Box to Box	4.25"
956-0101	16"	2.875" Reg Box to Box	4.25"
956-0102	18"	2.875" Reg Box to Box	4.25"
956-0103	20"	2.875" Reg Box to Box	4.25"
956-0104	24"	2.875" Reg Box to Box	4.25"
956-0105	28"	2.875" Reg Box to Box	4.25"
956-0106	30"	2.875" Reg Box to Box	4.25"
956-0107	34"	2.875" Reg Box to Box	4.25"
956-0108	36"	2.875" Reg Box to Box	4.25"
956-0173	32"	2.875" Reg Box to Box	4.25"



*“Radius is an industry leader in the HDD community with incredible customer service and professionally trained salesman and technicians. Their pricing and turnaround is by far the best in the business.”*

-Joe Hreha Jr.

## Paddle Reamer For clay, dirt and sticky soils.

- Paddle design provides both aggressive cutting and efficient fluid mixing/pumping action.
- Low-resistance profile requires less horsepower for rotation in a variety of soil conditions.
- Reduced surface area minimizes clay and cuttings build up.

Paddle Reamers			
Part #	Cutting Size	Connection	Shaft Diameter
956-0048	6"	2" IF Box x Box	2.75"
956-0049	8"	2" IF Box x Box	2.75"
956-0050	10"	2" IF Box x Box	2.75"
956-0051	12"	2" IF Box x Box	2.75"
956-0052	14"	2" IF Box x Box	2.75"
956-0053	16"	2" IF Box x Box	2.75"
956-0054	18"	2" IF Box x Box	2.75"
956-0055	20"	2" IF Box x Box	2.75"
956-0056	22"	2" IF Box x Box	2.75"
956-0057	6"	2.375" Reg Box x Box	3.5"
956-0058	8"	2.375" Reg Box x Box	3.5"
956-0059	10"	2.375" Reg Box x Box	3.5"
956-0060	12"	2.375" Reg Box x Box	3.5"
956-0061	14"	2.375" Reg Box x Box	3.5"
956-0062	16"	2.375" Reg Box x Box	3.5"
956-0063	18"	2.375" Reg Box x Box	3.5"
956-0064	20"	2.375" Reg Box x Box	3.5"
956-0065	24"	2.375" Reg Box x Box	3.5"
956-0066	26"	2.375" Reg Box x Box	3.5"
956-0067	10"	2.875" Reg Box to Box	4.25"
956-0068	12"	2.875" Reg Box to Box	4.25"
956-0069	14"	2.875" Reg Box to Box	4.25"
956-0070	16"	2.875" Reg Box to Box	4.25"
956-0071	18"	2.875" Reg Box to Box	4.25"
956-0072	20"	2.875" Reg Box to Box	4.25"
956-0073	22"	2.875" Reg Box to Box	4.25"
956-0074	24"	2.875" Reg Box to Box	4.25"
956-0136	26"	2.875" Reg Box to Box	4.25"
956-0075	28"	2.875" Reg Box to Box	4.25"
956-0076	30"	2.875" Reg Box to Box	4.25"
956-0077	32"	2.875" Reg Box to Box	4.25"
956-0078	34"	2.875" Reg Box to Box	4.25"
956-0079	36"	2.875" Reg Box to Box	4.25"



## Compact Fluted Reamer For medium to tough soil conditions including hard soil and chunk rock.

- Deep-fluted design effectively and efficiently directs slurry flow past reamer and out of the hole.
- Built-in swivel for quick and reliable pullback.
- Carbide inserts strengthen teeth for better cutting performance.
- Precision-positioned fluid ports for efficient mixing and lubrication.

Fluted Reamers		
Part #	Cutting Size	Connection
956-0001	4.5"	2" IF Box x 12K Swivel
956-0003	6.5" (Conical)	2" IF Box x 12K Swivel
956-0002	6.5"	2" IF Box x 12K Swivel
956-0004	8"	2.375" Reg Box x 20K Swivel
956-0005	8" (Conical)	2.375" Reg Box x 20K Swivel
956-0006	10"	2.375" Reg Box x 30K Swivel
956-0007	10" (Conical)	2.375" Reg Box x 30K Swivel
956-0010	12"	2.375" Reg Box x 30K Swivel
956-0009	12" (Conical)	2.375" Reg Box x 30K Swivel



## Stack Plate Reamer For extreme conditions such as hard rock, chunk rock and cobble.

- Thickest plates on the market (1 ½" steel) with interior welds to minimize wear. The competition welds their plates on the outside where they are exposed to damaging conditions.
- Maximum number of cutters available on the market today, precisely placed for an extremely smooth cutting action.
- Stacked plates are tapered and rotated slightly, creating spiraled flutes for evacuating spoils.
- Wear edges reinforced with hardfacing for longer life.

### Stack Plate Reamers

Part #	Cutting Size	Connection	Shaft Diameter
956-0011	8"	2.375" API Reg Box x Box	3.5"
956-0012	10"	2.375" API Reg Box x Box	3.5"
956-0013	12"	2.375" API Reg Box x Box	3.5"
956-0014	14"	2.375" API Reg Box x Box	3.5"
956-0015	16"	2.375" API Reg Box x Box	3.5"
956-0016	18"	2.375" API Reg Box x Box	3.5"
956-0017	20"	2.375" API Reg Box x Box	3.5"
956-0018	10"	2.875" Reg Box x Box	4.25"
956-0019	12"	2.875" Reg Box x Box	4.25"
956-0020	14"	2.875" Reg Box x Box	4.25"
956-0021	16"	2.875" Reg Box x Box	4.25"
956-0022	18"	2.875" Reg Box x Box	4.25"
956-0023	20"	2.875" Reg Box x Box	4.25"
956-0024	24"	2.875" Reg Box x Box	4.25"
956-0025	26"	2.875" Reg Box x Box	4.25"
956-0026	28"	2.875" Reg Box x Box	4.25"
956-0027	30"	2.875" Reg Box x Box	4.25"
956-0028	32"	2.875" Reg Box x Box	4.25"
956-0029	34"	2.875" Reg Box x Box	4.25"
956-0030	36"	2.875" Reg Box x Box	4.25"

**Find  
connection  
subs**  
on pages 14-17.



## The All New Radius® Over-Bit Reamer

The new Radius Overbit Reamer eliminates completely the need to remove pilot tools to attach a reamer. Designed for fiber and small bore contractors, the Overbit Reamer simply attaches over the pilot bit and secures with one bolt. It offers the simplicity your crews have been looking for and perfect in small exit pits - No collars, no wrenches or tongs. With the pilot tool attached the sonde can be used to locate through tight easements or intersects. Designed exclusively for 2700 and 3500 series Radius rock bit.

### Radius Over-Bit Reamer

Part #	Description	
956-0496	6" Radius Over-Bit Reamer Fits 2700 Series	
956-0497	8" Radius Over-Bit Reamer Fits 3000 Series	
SPL-0020	2750 Series Rock Bit & 6" Over-Bit Bundle	
SPL-0021	3000 Series Rock Bit & 8" Over-Bit Bundle	

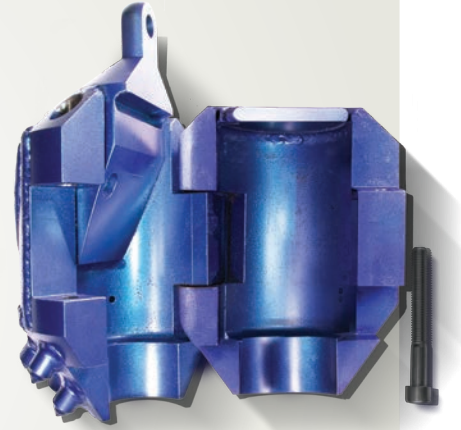

# SWIVELS. SUPER STRONG AND IN STOCK.

Radius offers some of the leading HDD swivels on the market today with a unique design that's one of the strongest available. Three bearings and a larger shaft built with toolsteel construction eliminate the fold-over you can get on other swivels. A smooth outside ensures a no-snag pull back.

## DCD & Conduct Swivels

Radius is proud to offer DCD swivels as part of our professional line of HDD tools. Available in a variety of sizes and connections, Radius has a huge selection of swivel and pulling products. A 5:1 safe work load on Deluxe swivels offers confidence and reliability, while Dublite swivels are a dependable and more economical choice. Either way, you can count on DCD swivels to get you back.

### Condux® Clevis x Clevis Value Swivels

Part #	Description	Clevis ID	Safe Work Load
954-0044	4.25 Ton, 1.625" OD	5/8"	3 to 1
954-0045	5 Ton, 2" OD	3/4"	3 to 1
954-0047	10 Ton, 2.5" OD	1"	3 to 1
954-0048	15 Ton, 3" OD	1 - 5/16"	3 to 1



### DCD Clevis to Clevis Dublite Swivel

Part #	Description	Clevis ID	Safe Work Load
954-0035	4.25 Ton, 1.625" OD	5/8"	3 to 1
954-0036	5 Ton, 2" OD	3/4"	3 to 1
954-0037	10 Ton, 2.5" OD	1"	3 to 1
954-0038	15 Ton, 3" OD	1 - 5/16"	3 to 1
954-0039	20 Ton, 4" OD	1 - 5/8"	3 to 1
954-0040	30 Ton, 4.5" OD	1 - 3/4"	3 to 1
954-0041	45 Ton, 5.75" OD	2"	3 to 1
954-0042	60 Ton, 6.5" OD	2.25"	3 to 1



## DCD Clevis to Clevis Dublite Swivels

Part #	Description	Clevis ID	Safe Work Load
954-0550	4 1/4 Ton, 2" OD	3/4"	3 to 1
954-0551	5 Ton, 2.25" OD	7/8"	3 to 1
954-0552	10 Ton, 2.5" OD	1"	3 to 1
954-0553	15 Ton, 3" OD	1 - 5/16"	3 to 1
954-0792	20 Ton, 4.75" OD	1 - 3/4"	3 to 1
954-0793	30 Ton, 5.75" OD	1 - 3/4"	3 to 1
954-0794	45 Ton, 6" OD	1 - 3/4"	3 to 1



## DCD Clevis to Clevis Dub Swivels

Part #	Description	Clevis ID	Safe Work Load
954-0690	5 Ton, 3.125" OD	1 - 1/4"	5 to 1
954-0691	10 Ton, 3.75" OD	1 - 1/2"	5 to 1
954-0692	15 Ton, 4.75" OD	1 - 3/4"	5 to 1
954-0693	20 Ton, 5.75" OD	1 - 3/4"	5 to 1
954-0694	30 Ton, 6" OD	1 - 3/4"	5 to 1
954-0695	40 Ton, 6.5" OD	2 - 1/8"	5 to 1
954-0560	60 Ton, 7.5" OD	2 - 3/4"	5 to 1



## DCD Clevis to IF Dub Swivels

Part #	Description	Clevis ID	Safe Work Load
954-0026	15 Ton, 2-3/8" IF Box, 4-3/4" OD	1 - 3/4"	5 to 1
954-0027	20 Ton, 2-3/8" IF Box, 5-3/4" OD	1 - 3/4"	5 to 1
954-0028	20 Ton, 2-7/8" IF Box, 5-3/4" OD	1 - 3/4"	5 to 1
954-0029	30 Ton, 2-7/8" IF Box, 6" OD	1 - 3/4"	5 to 1
954-0030	30 Ton, 3-1/2" IF Box, 6" OD	1 - 3/4"	5 to 1
954-0031	40 Ton, 3-1/2" IF Box, 6.5" OD	2 - 1/8"	5 to 1
954-0032	40 Ton, 4-1/2" IF Box, 6.5" OD	2 - 1/8"	5 to 1
954-0033	60 Ton, 4-1/2" IF Box, 7.5" OD	2 - 3/4"	5 to 1
954-0034	80 Ton, 4-1/2" IF Box, 9" OD	3 - 1/4"	5 to 1



## Flange Swivels

Made in the USA from high-strength alloy steel and high-quality precision bearings, our flange swivels are specifically designed to withstand the rigors of directional boring. Each swivel is dynamically tested at the rated load with full pull and rotation for 100 hours. Radius flange swivels also feature convenient side access to grease zerk so you can grease the bearing without disassembly.

### Flange Swivels

Part #	Description
954-0052	10K x 4.5" & 6" Ditch Witch® Compatible Fluted Reamer Swivel
954-0053	20K x 8" Ditch Witch® Compatible Fluted Reamer Swivel
954-0054	30K x 10" & 12" Ditch Witch® Compatible Fluted Reamer Swivel
954-0826	40K Ditch Witch® Compatible Flange Swivel
954-0954	100K Ditch Witch® Compatible Flange Swivel
954-0863	15 Ton Dublite Flange Swivel
954-0871	30 Ton Dub Flange Swivel
954-0451	15 Ton Lewis MFG Flange Swivel
954-0452	25 Ton Lewis MFG Flange Swivel



Parts and Accessories

# EVERYTHING YOU NEED. ALL IN ONE PLACE.

**We've said it before: our job is to make your job easier.**

And that means not only carrying the best HDD tools available, it means putting just about anything an HDD pro needs right here at your fingertips. Batteries to bolts. Hard hats to housing doors. Ponchos to pullers. Caution tape to clevis pins. Rod wipers to ... well, you get the idea.

*“Great quality tooling, excellent customer service, known worldwide for their products. Would recommend their top-of-the-line products to anyone in the HDD industry.”*

*-Rich Grolbert*



## Pullers & Pulling Accessories

Whatever your pipe type or size, Radius has the pullers and pulling accessories you need.

### Sleeved Puller

Part #	Description
954-0113	1.25" Duct
954-0114	1.5" Duct
954-0115	2" Duct
954-0116	2.5" Duct
954-0117	3" Duct
954-0118	4" Duct
954-0119	5" Duct
954-0120	6" Duct

### Expandable Duct Puller

Part #	Description
954-0122	.5" Duct
954-0123	1" Duct
954-0124	1.25" Duct
954-0125	1.5" Duct
954-0126	2" Duct
954-0127	2.5" Duct
954-0128	3" Duct
954-0129	4" Duct
954-0130	5" Duct
954-0131	6" Duct
954-0132	8" Duct
954-0276	10" Duct
954-0277	12" Duct

### Carrot Puller with Eye

Part #	Description
954-0133	.5" to 1" Duct
954-0134	1" Duct
954-0135	1" to 1.25" Duct
954-0136	1.25" Duct
954-0137	1.25" to 1.5" Duct
954-0138	1.5" Duct
954-0139	2" Duct

### Other Pullers

Part #	Description
954-0502	Pest Duct Puller, 1.25"
954-0503	Sleeveless Duct Puller, 2" Duct
954-0504	Dub Wise Puller (Sleeved), 1.5" Duct
954-0505	Dub Wise Puller (Sleeved), 2" Duct
954-0506	Dub Wise Puller (Sleeved), 4" Duct



4" Sleeved Puller



2" Expandable Puller



1.25" Carrot Puller



Dub Wise Puller

## Pullers & Pulling Accessories, cont'd.

### Mesh Pulling Grips

Part #	Description	Length	Capacity
954-0140	Stnd Ditch Witch® Compatible Mesh Grip, .25" - .5" Duct	18" OAL	1700 lbs
954-0142	Stnd Ditch Witch® Compatible Mesh Grip, .5" - .75" Duct	18" OAL	2000 lbs
954-0143	Stnd Ditch Witch® Compatible Mesh Grip, .75" - 1.25" Duct	18" OAL	2000 lbs
954-0145	Stnd Wire Mesh Grip, 1.25" - 2" Duct	26" OAL	2500 lbs
954-0146	Stnd Wire Mesh Grip, 2" - 2.75" Duct	32" OAL	3500 lbs
954-0147	HD Wire Mesh Grip, .5" - .75" Duct	24" OAL	2600 lbs
954-0148	HD Wire Mesh Grip, .75" - 1.25" Duct	24" OAL	3500 lbs
954-0149	HD Wire Mesh Grip, 1.25" - 2" Duct	32" OAL	3500 lbs
954-0150	HD Wire Mesh Grip, 2" - 2.75" Duct	38" OAL	4500 lbs
954-0152	HD Wire Mesh Grip, 2.75" - 3.5" Duct	38" OAL	4500 lbs
954-0153	HD Wire Mesh Grip, 3.5" - 4.25" Duct	46" OAL	5500 lbs
954-0154	HD Wire Mesh Grip, 4.25" - 4.875" Duct	52" OAL	6500 lbs



### Polyester Pulling Tape

Part #	Description
954-0344	.25" - 3000' Length - 900#
954-0345	.375" - 6500' Length - 1130#
954-0346	.625" - 3000' Length - 1800#
954-0347	.75" - 5000' Length - 2500#



### Conduit Measuring Tape

Part #	Description
954-0348	.1875" - 3000' Length - 160#

*“Friendly and fast service , was in a pinch and needed down hole wire and they delivered.”*

-Ricky Tharp II

### Pulling Shackles

Part #	Product	Style	Work Load Limit
954-0802	.375"	Screw Pin	2,000 lbs
954-0845	.4375"	Screw Pin	3,000 lbs
954-0107	.5"	Screw Pin	6,600 lbs
954-0108	.625"	Screw Pin	6,500 lbs
954-0109	.75"	Screw Pin	14,000 lbs
954-0110	.875"	Screw Pin	13,000 lbs
954-0111	1"	Screw Pin	17,000 lbs
954-1044	1.25"	Screw Pin	24,000 lbs
954-0112	1.375"	Screw Pin	27,000 lbs
954-0622	1.5"	Screw Pin	34,000 lbs
954-0623	1.75"	Screw Pin	50,000 lbs
954-0624	2"	Screw Pin	70,000 lbs



# Rod Wipers, Vice Jaws & Inserts

Get a grip with tough Radius vice jaws, and keep your drill rods clean with our affordable rod wipers.

Vermeer® Compatible OEM Vice Jaws		
Part #	Fits Model	Full set replacement req
954-0080	D7x11 & D10x15 Stationary D9x13 Stationary	2 4
954-0081	D7x11 & D10x15 Cylinder	2
954-0082	D16x20 Stationary	2
954-0083	D16x20 Cylinder	2
954-0366	D20x22 Cylinder	2
954-0367	D20x22 Stationary	2
954-0965	D23x30 Cylinder	2
954-0966	D23x30 Stationary	2
954-0084	D24x40 Stationary	4
954-0085	D33x44 / D36x50 Stationary (FS650)	4
954-0088	D36x50 / 40x55 Stationary (FS700)	4
954-0090	D60x90 / 50x100 Cylinder	4
954-0093	D50x100 / 80x100 Cylinder	4

Vermeer® Compatible Blocks & Inserts		
Part #	Fits Model	Full set replacement req
954-0086	D7x11 / D16x20 / 20x22 / 23x30 Stationary D9x13 Stationary	2 4
954-0089	D7x11 / D16x20 / 20x22 / 23x30 Cylinder	2
954-0091	D7x11 / D9x13 Insert	4
954-0092	D16x20 / 20x22	4
954-0363	D23x30 / D24x40 Insert	4
954-0364	D24x40 / 33x44 / 36x50 / 40x55	4
954-0087	D33x44 / 36x50 Insert (FS650)	4
954-0362	D36x50 / 40x55 Insert (FS700)	4
954-0365	D60x90 / 50x100 / 80x100 / 100x120 Cylinder	4
954-0915	D100x120 / 100x140 Stationary (New Style)	4
954-0094	D60x90/50x100/80x100/100x120/100x140 Insert	8
954-0457	D60x90/50x100/80x100/100x120/100x140 Diamond Insert	8

Ditch Witch® Compatible Insert Jaws		
Part #	Fits Model	Full set replacement requires
954-0100	JT100 Mach1	8 inserts
954-0099	JT4020 Mach1	8 inserts
954-0098	JT2720 Mach1	8 inserts
954-0097	JT3020 Mach1 3020AT	4 blocks
954-0096	JT922 Coarse Thread JT2020 Mach1 JT1220 Mach1	4 blocks
954-0095	JT5	4 blocks
954-0379	JT922 Fine Thread	4 blocks

Wire Pulling Collars	
Part #	Description
954-0368	2 Leg Pulling Collar - 2000lb Capacity
954-0369	4 Leg Pulling Collar - 2000lb Capacity
954-0370	2 Leg Pulling Collar - 5500lb Capacity
954-0371	4 Leg Pulling Collar - 5500lb Capacity
954-0372	2 Leg Pulling Collar - 8200lb Capacity
954-0373	4 Leg Pulling Collar - 8200lb Capacity
954-0374	2 Leg Pulling Collar - 9800lb Capacity
954-0375	4 Leg Pulling Collar - 9800lb Capacity

OEM Vice Jaw



D7x11/D16x20 Block Hydraulic

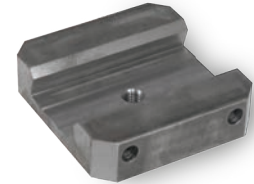

Inserts



4" Dual Split Rod Wiper



1.125" Single Rod Wiper



## Dual Split Rod Wipers

Part #	Drill Rod Diameter
954-0469	2.125" ID, 9" O.D.
954-0470	2.375" ID, 9" O.D.
954-0471	2.75" ID, 9" O.D.
954-0472	3" ID, 9" O.D.
954-0486	1.5" ID, 9" O.D.
954-0487	1.75" ID, 9" O.D.
954-0488	1.875" ID, 9" O.D.
954-0473	3.5" ID, 14" O.D.
954-0474	4" ID, 14" O.D.
954-0716	2.5" ID, 14" O.D.

## Single Rod Wipers

Part #	Drill Rod Diameter
954-0101	1.125"
954-0102	1.66"
954-0103	1.9" - 2.06"
954-0104	2.375"
954-0105	2.875"
954-0106	3.5"

Drive Chucks & Sub Savers

Starter Rods & Quick Connects

Adapters & Subs

Housings

Rock Tools

Bits & Blades

Reamers

Swivels

PARTS & ACCESSORIES

Repairs

## Thread Identification Kit

The Radius thread ID kit makes it easy to know exactly what thread you have, or more importantly, which thread you need.

Ordering the wrong thread or sub can cost thousands in downtime and delays. This kit contains a number of thread gauges to easily identify all sizes of Vermeer® pipe and quick connect threads, Ditch Witch® pipe and EZ connection threads, API regular and IF Threads as well as other OEM threads common to HDD.

The Radius thread ID kits is also very useful in identifying various unknown subs in your yard that have plenty of useful life left.



Thread Identification Kit	
Part #	Description
954-0159	Thread Identification Kit

## Lubricants and Grease

Lubricants & Grease		
Part #	Description	Size
954-0067	HD Drill Collar & Tool Joint	1 gallon
954-0068	HD Drill Collar & Tool Joint	2 gallon
954-0069	HD Drill Collar & Tool Joint	5 gallon
954-0070	Drill Collar & Tool Joint Compound	14 oz
954-0419	<b>ECO-SAFE</b> Drill Collar & Tool Joint Compound	1 gallon
954-0378	<b>ECO-SAFE</b> Drill Collar & Tool Joint Compound	2 gallon
954-0448	<b>ECO-SAFE</b> Drill Collar & Tool Joint Compound	5 gallon
954-0795	Drill Collar & Tool Joint Compound	1 gallon
954-0796	Drill Collar & Tool Joint Compound	2 gallon
954-0797	Drill Collar & Tool Joint Compound	5 gallon



Drilling Mud and Additives		
Part #	Product	Info
954-0440	Hydraul-EZ 50 LB Bag	
954-0549	30" Dope Brush	Applicator for Antiseize
954-0580	Super Gel X	HY Bentonite, 200 BBL, 50LB Bag
954-0581	Cetco Drill-Terge	Wetting Agent, 5 Gallon Pail
954-0582	Cetco Insta-Visplus	Liquid drilling polymer, 5 Gallon
954-0583	Cetco Claycutter	Clay Inhibitor, 5 Gallon Pail
954-0584	Cetco Superthin	Drilling Fluid Thinner 5 Gallon
954-0585	Cetco Soda Ash	Sodium Carbonate, PH Balancer
954-0974	Cetco Clay Cutter Dry	Clay In hibitor, 20lb Pail
954-1000	Insta-Vis Dry	Drilling Polymer, 14lb Pail



# Work Gear & Jobsite Supplies

Your job is tough enough. Why make it harder going place to place to find what you need for the jobsite? We've got you covered, right here.

Job Site Supplies	
Part #	Description
954-0161	Contractor Shovel
954-0162	Soil Probe / Rod
954-0447	Liquid-Lok 250 Thread Locker 2 Part Epoxy Resin/Activator
954-0509	Vise Wrench Set, Manual (3000lb-ft)
954-0711	Petol SLM Grip Tongs, 1" - 2-1/4" OD, 16" Handle
954-0712	Petol SLM Grip Tongs, 2-3/8"-4" OD, 28" Handle
954-0713	Petol SLM Grip Tongs, 3-3/4"-6-1/2" OD, 33" Handle
954-0976	Overshot Fishing Tool, 2-3/8" Reg Pin, 1" to 3.5"
954-0977	Overshot Fishing Tool, 2-7/8" Reg Pin, 2" to 4"
954-0978	Overshot Fishing Tool, 3-1/2" Reg Pin, 3" to 5"
954-0958	Ridgid Pipe Wrench, 60" OAL

Electrical Protection		
Part #	Product	Info
954-0652	Servus Dielectric Overshoes w/ 2 Buckles 20K VR	Size 8
954-0653	Servus Dielectric Overshoes w/ 2 Buckles 20K VR	Size 9
954-0654	Servus Dielectric Overshoes w/ 2 Buckles 20K VR	Size 10
954-0655	Servus Dielectric Overshoes w/ 2 Buckles 20K VR	Size 11
954-0656	Servus Dielectric Overshoes w/ 2 Buckles 20K VR	Size 12
954-0657	Servus Dielectric Overshoes w/ 2 Buckles 20K VR	Size 13
954-0769	Servus Dielectric Overshoes w/ 2 Buckles 20K VR	Size 14
954-0770	Servus Dielectric Overboots w/ 1 Buckles 20K VR	Size 9
954-0771	Servus Dielectric Overboots w/ 1 Buckles 20K VR	Size 10
954-0772	Servus Dielectric Overboots w/ 1 Buckles 20K VR	Size 11
954-0773	Servus Dielectric Overboots w/ 1 Buckles 20K VR	Size 12
954-0774	Servus Dielectric Overboots w/ 1 Buckles 20K VR	Size 13
954-0775	Servus Dielectric Overboots w/ 1 Buckles 20K VR	Size 14

Batteries	
Part #	Description
954-0402	CT-Silver Lithium Super Cell
954-0403	CT-Blue Lithium
954-0404	NI-CD Rechargeable
954-0728	F Series Battery Pack

Wireline		
Part #	Product	Info
954-0314	Wireline Adapter	
954-0438	Wireline Adapter Kit	
954-0459	Black Heat Shrink W/ Sealant	3/8" x 4ft (2 to 1 Shrink)
954-0460	Downhole Wire	10/7 strand 45mil, 1000ft reel
954-0461	Nicopress Wire Sleeves	FW-2-3 3/4
954-0462	Crimping Tool #51	Wireline crimpers
954-0463	2.875 IF Spider	
954-0464	3.5 IF Spider	
954-0970	Down Hole Spider	10/7 Strand 45mil, 500ft reel
954-0821	End Load Wireline Kit	
954-0799	Wireline Butt Connector 100ct Bag	
954-0800	Wireline Crimping Tool For Butt Connectors	
954-0784	Clear Heat Shrink W/ Sealant	3/8" x 4ft (2 to 1 Shrink)
954-0885	6-5/8" Wireline Spider	



Drive Chucks & Sub Savers

Starter Rods & Quick Connects

Adapters & Subs

Housings

Rock Tools

Bits & Blades

Reamers

Swivels

PARTS & ACCESSORIES

Repairs

## Drill Pipe

Drill Pipe		
Part #	Description	Info
PIP-0020	2-7/8" IF Drill Pipe	3.500 x 15' DD-6
PIP-0025	TT4X	1.660 x 5'
PIP-0011	CASE 6010	2.063 x 10'
PIP-0015	CASE 6030	2.375 x 10'

DITCH WITCH® Compatible Drill Pipe		
Part #	Description	Info
PIP-0002	JT 920/921	1.660 x 6'
PIP-0003	JT 922	1.660 x 6'
PIP-0005	JT 920L	1.660 x 10'
PIP-0006	JT 1220	1.900 x 10'
PIP-0008	JT1720	2.063 x 10'
PIP-0010	JT2020	2.063 x 10'
PIP-0012	JT2720	2.375 x 10'
PIP-0013	JT2720M1 / JT3020M1	2.375 x 10'
PIP-0017	JT4020	2.875 x 15'
PIP-0018	JT4020M1	2.875 x 15'
PIP-0021	JT7020	3.500 x 15'

Vermeer® Compatible Drill Pipe		
Part #	Description	Info
PIP-0001	D 7x11	1.660 x 6'
PIP-0004	D 10 x 15	1.660 x 10'
PIP-0007	D1620	1.900 x 10'
PIP-0009	D20x22 / D24x26	2.063 x 10'
PIP-0014	D24x40	2.375 x 10'
PIP-0016	D50x100 / D60x90	2.875 x 15'
PIP-0019	D80x100	3.500 x 15'
PIP-0023	D100x120	3.500 x 20'
PIP-0035	D33x44/36x50	2.375 x 10' (FS650)
PIP-0036	D33x44/36x50	2.375 x 15' (FS650)
PIP-0037	D36x50/40x55	2.625 x 10' (FS700)
PIP-0038	D36x50/40x55	2.625 x 15' (FS700)

Our full line of parts and accessories  
is also available online at  
[www.RadiusHDD.com](http://www.RadiusHDD.com)



# NEED REPAIRS? RADIUS® HAS YOUR BACK.

Radius offers a full line of repair services to maximize your tooling life and reduce the risk of losing tools down hole.

## PDC Repairs

Maintaining your PDC bit is critical to its performance. Radius offers inspections, maintenance and repair services for all sizes and types of PDC Bits. From simply rotating cutters to body repairs and full cutter replacement, Radius has the experience and capability to maximize your PDC tool investment.



## Rock Bit Repairs

Radius offers repair services on all brands of HDD pilot tools, from simple carbide replacement to full body rebuilds. There is no charge for the evaluation and inspection in order to assist you in determining the value of repairing your tooling.



## Hole Opener & Reamer Repairs

Let Radius extend the life of your hole openers and reamers with a thorough evaluation and inspection, replacing failed cones or cutters, rebuilding worn areas, hardfacing application and thread repairs.



## AT & DR Inner Rod Repairs

For contractors who run AT or DR rigs, Radius now offers an Inner Rod repair service that rebuilds and machines worn inner shafts back to original specifications at a much lower cost than a new replacement rod. Give us a call to learn more about our "Rod Swap" plan to minimize your downtime.



Drive Chucks & Side Savers

Starter Rods & Quick Connects

Adapters & Subs

Housings

Rock Tools

Bits & Blades

Reamers

Swivels

PARTS & ACCESSORIES

REPAIRS



**Know what's below.  
Call before you dig.**



PO BOX 3106 Weatherford, TX 76086 | Phone: 800-892-9114

Copyright 2019 Radius HDD Direct, LLC. | A Charles Machine Works Company

Radius is a registered trademark of Radius HDD Direct, LLC. Astec is a registered trademark of Astec Underground. American Augers is a registered trademark of Astec Industries, Inc. Condux is a registered trademark of Condux International, Inc. Ditch Witch and Subsite are registered trademarks of The Charles Machine Works, Inc. Digitrak is owned by DCI, Toro owned by Toro Manufacturing, Grundodrill owned by Tracto-Technik. Ramon is a registered trademark of Railhead Underground Products, LLC. Vermeer, Firestick are trademarks of Vermeer Manufacturing Company.